

Tuning Fork Analytical Balance

HT/HTR CEN Series

Operation Manual

IMPORTANT

- To ensure safe and proper use of the balance, please read this manual carefully.
- After reading this manual, store it in a safe place near the balance, so you can review it as needed.

SHINKO DENSHI CO., LTD.

Preface

Thank you very much for having purchased our Tuning-Fork Electronic Analytical Balance HT/HTR CEN series.

This document describes how to operate the product.

Instructions

- The copyright of this document belongs to SHINKO DENSHI CO., LTD.. Reprinting or duplicating of all or part of this document without notice shall not be allowed.
- Please note that product improvement or modification may cause partial discrepancy between the product and the description of this document.
- The description of this document is subject to change without notice.
- This document has been created carefully. In case that, however, any error or imperfection is found by any chance, please let us know.
- Documents of which pages are missing or irregularly bound will be exchanged. Please inform the store where you purchased the product.
- Trouble related to the product or system will be dealt with in accordance with the individual maintenance contract. Please note, however, that we will not take responsibility for consequential trouble such as discontinuation of operation caused by the product trouble.
- **VIBRA** is the registered trademark of SHINKO DENSHI CO., LTD.. Company names and product names appearing in this document are the trademarks or registered trademarks of the respective company concerned.

Important Notice











- It should be known that this product contains potential danger. And so please be sure to observe this document when installing, operating or servicing this product.
- SHINKO DENSHI CO., LTD. will not take any responsibility for any injury or damage caused by the non-observance of this document or misuse or unauthorized modification of this product.

- Potential dangers are increasing in the industrial equipment industries due to the advent of new materials and processing methods, and speeding up of machines. It is impossible to foresee all situations related to these dangers. In addition, there are so many “impossible” and “don’ts” and so writing all of them in the operation manual is impossible. Therefore, it is safe to think that what is not written in the operation manual “cannot be performed” unless the operation manual positively writes “it is possible.” When performing installation, operation, maintenance or inspection of this product, not only observe what is written or indicated in this document or on the product surface but also pay adequate consideration to safety measures.
- The copyright of this document is held and reserved by SHINKO DENSHI CO., LTD.. Duplicating or disclosing its drawings and engineering materials without prior approval of SHINKO DENSHI CO., LTD. in writing is not permitted.
- For any question or further information concerning this document, please contact the store where you purchased the product or with its model (type) name and serial number informed.
- Manufacturer: SHINKO DENSHI CO., LTD.
Address: 3-9-11 Yushima, Bunkyo-ku, Tokyo 113-0034 JAPAN

How to use this document

■ Symbols used in this document

Understand the meaning of the following symbols and observe the instructions of this document.

Symbols	Meaning
	Used for high risk point concerning the operations that may lead to death or severe physical injury to persons if proper precautions are not taken.
	Used for warning concerning the operations that may lead to death or severe physical injury to persons, if proper precautions are not taken.
	Used for caution concerning operations that may lead to a light physical injury to persons or damage of the products/facilities if proper precautions are not taken.
	Used for notation for avoiding from deletion, overwrite of the weighing data or for accurate weighing and appropriate usage of the equipment.
	Used for referenced information which is useful for product operation.
	Used for "Prohibition" items
	Used for "Mandatory" items requiring positive action
	Used for prohibition items to avoid "Electrical shock".
	This symbol indicates the operation/specification in related to the verified balance for legal metrology.

This product/ The product/The balance	Refers to the product.
[On/Off] key	The name of an operation key located in front of the main unit is represented in square brackets "[]".
<message>	A message on the display is represented in angle brackets "< >".
<<F1>>	"Free key" or "Shortcut" is represented in double angle brackets "<< >>".
Push the key	Signifies pushing lightly an operation key once.
Push the key long	Signifies keeping pushing an operation key until the designated indication appears.

■ About how to read this document

This document consists of the following contents:

1	Prior to use	Describes about operating precautions, names and functions of each section, etc. Please be sure to read this section when using this product for the first time.
2	Basic usage	Describes about basic usage related to weighing such as how to turn on and off the power in addition to the setting procedures to set various functions.
3	Functions related to the operation	Describes about setting items to change the operation of the balance.
4	Function related to the performance	Describes about setting items related to the indication stability and the response speed of the balance.
5	User information setting	Describes about setting items related to the upper and lower limits and preset tare weight.
6	External input/output functions	Describes about setting items related to the specifications and conditions in regard to the external communication.
7	Functions related to the lock	Describes about setting items related to change prohibitions and invalid keystrokes on each menu item.
8	Controlling and adjustment functions	Describes about setting items related to the product administrator.
9	Troubleshooting	Describes about methods of troubleshooting this product such as how to respond to errors and when you are in need of help.
10	How to maintain	Describes how to maintain this product.
	Appendix	Provides necessary data such as the specifications of this product.

Contents

Preface.....	i
Important Notice	ii
How to use this document	iii
Contents	v
1 Prior to use	1
1-1 Operating precautions	1
1-2 For more accurate measurement	3
1-2-1 Precautions related to measuring environment.....	3
1-2-2 Precautions related to measuring table.....	3
1-2-3 Precautions related to a specimen.....	4
1-2-4 Precautions related to the main unit of a balance	4
1-3 Check for the articles contained in the box.....	5
1-4 Name and function of each section	6
1-5 Assembling and installation of the product	7
1-5-1 Assembling the balance	7
1-5-2 Level	8
1-6 Description of the operation keys	9
1-6-1 Basic	9
1-6-2 Setting value and numeric value inputting.....	10
1-7 How to interpret the display.....	11
1-7-1 Description of segment.	11
1-7-2 LCD character font.....	12
2 Basic usage	13
2-1 Turning on/off the power, and checking for the operation.....	13
2-2 Zero-point adjustment	14
2-2-1 Zero-point adjustment range	14
2-3 Weighing a sample placed on a container (tare)	15
2-4 Weighing the additional sample	16
2-5 Basic operation	16
2-5-1 Hierarchy of a setting menu	16
2-5-2 Operation of the setting menu.....	17
2-5-3 Numeric value input	18
2-5-4 [F] key switching at each measuring mode	19
3 Functions related to the operation	20
3-1 Hierarchy of functions related to the operation	20
3-2 Various measuring modes of the balance	21
3-2-1 Weighing mode	21
3-2-2 Counting mode.....	22
3-2-2 (1) Actual value setting method.....	22
3-2-2 (2) Numeric value setting method	24
3-2-2 (3) Switching the display at Counting mode.....	24
3-3 Percentage mode	25
3-3-1 Switching the display at percentage mode.....	26
3-4 Multiplied by Coefficient mode	27
3-4-1 Switching the display at Multiplied by Coefficient.....	28
3-5 Specific gravity mode	28
3-5-1 Procedure for measuring specific gravity of the solid sample.....	28
3-5-2 Switching the display at "Specific gravity mode"	30
3-6 Unit setting	31
3-7 Comparator function.....	31



3-7-1	How to perform discrimination.....	31
3-7-2	Comparator function setting	32
3-8	Adding function	33
3-8-1	Weighing by means of the plus side addition	34
3-8-2	Weighing by means of the minus side addition	35
3-9	Tare-subtraction reminder function	36
3-10	Zero-point-adjustment reminder function	37
3-11	Stabilization wait setting	37
3-12	Bar graph indication	38
3-13	Backlight setting	38
3-14	Auto power-off	39
3-15	“Simple SCS(Self Counting System) method” setting	39
4	Functions related to the performance	40
4-1	Hierarchy of functions related to the performance.....	40
4-2	Stability discrimination width.....	40
4-3	Response speed	41
4-4	Zero tracking	41
5	User information setting.....	42
5-1	Hierarchy of user information setting.....	42
5-2	Preset tare.....	43
5-2-1	Preset tare setting	43
5-2-2	Inputting of a preset tare weight value	43
5-2-2 (1)	Actual value setting method.....	44
5-2-2 (2)	Numeric value setting method	44
5-2-2 (3)	Exiting the preset tare mode.....	44
5-3	Setting of the discrimination value of the comparator function	45
5-3-1	Actual value setting method	46
5-3-2	Numeric value setting method.....	46
6	External input/output functions	47
6-1	Hierarchy of the external input / output functions	47
6-2	Connector terminal numbers and their functions	48
6-2-1	D-SUB9P Connector	48
6-2-2	DIN8P Connector	48
6-3	Communication format	49
6-3-1	Basic communication specification	49
6-3-2	Basic data output format / CSP format	49
6-3-3	CBM data output format	51
6-3-4	Special format MF	53
6-3-5	Special format SF16/SF22	54
6-4	Input command	56
6-4-1	Transmission procedure.....	56
6-4-2	Input command composition 1	57
6-4-2 (1)	Zero-point adjustment/Tare/Output control setting command	57
6-4-2 (2)	Date output request and time output request.....	57
6-4-3	Input command composition 2	58
6-4-3 (1)	Comparator setting command.....	58
6-4-3 (2)	Preset tare value setting command	58
6-4-3 (3)	Interval (output) time setting command.....	58
6-5	Response	59
6-5-1	Response command format (“A00”/“Exx” format)	59
6-5-1(1)	Response command.....	59
6-5-2	Response command format (“ACK”/“NAK” format).....	59
6-5-2(1)	Response command.....	59

6-6	External contact input.....	59
6-7	Communication setting.....	59
7	Functions related to the lock.....	61
7-1	Hierarchy of functions related to the lock	61
7-2	Total lock release	61
7-3	Key lock function	62
7-4	Menu lock function	62
8	Controlling and adjustment functions.....	63
8-1	Hierarchy of controlling and adjustment functions.....	63
8-2	Shortcut setting for accessing various measuring modes	65
8-3	Free key setting.....	66
8-4	Maintenance settings	67
8-4-1	Span adjustment and span test.....	67
8-4-1(1)	Span adjustment with external weight.....	67
8-4-1(2)	Span test with external weight	69
8-4-1(3)	Semi-Automatic Span adjustment with internal weight	70
8-4-1(4)	Span test with internal weight	71
8-4-2	Automatic Repeatability Measurement (ARM)	72
8-4-3	Calibrating the internal weight.....	73
8-4-4	Restore the internal weight calibration value to default.....	74
8-4-5	Advice CAL and Automatic span adjustment.....	75
8-4-5(1)	Advice CAL.....	75
8-4-5(2)	Automatic Span Adjustment.....	76
8-4-6	Correction of the external calibration weight	77
8-5	Balance control setting.....	78
8-5-1	Balance ID setting.....	78
8-5-2	Password control	78
8-5-2 (1)	Administrator password registration.....	79
8-5-2 (2)	User password registration	79
8-5-3	Outputting of the span adjustment / test result.....	80
8-5-4	Date indication format	80
8-5-5	Date setting.....	81
8-5-6	Time setting.....	82
8-5-7	Output language	82
8-5-8	Readability Setting	83
8-5-9	Span adjustment with internal weight at power-on	83
8-5-10	Direct start setting	84
8-5-11	Initialize	84
9	Troubleshooting	85
9-1	Error message.....	85
10	How to maintain.....	88
Appendix	89
Appendix 1	Specification	89
Appendix 1-1	Basic Specification	89
Appendix 1-2	Functional specification	91
Appendix 2	Dimensional outline drawing.....	92
Appendix 3	Unit conversion table	93
Appendix 4	Weighing capacity and readability by unit.....	94
Appendix 5	Hanging measurement	96
Appendix 6	Balance operation with password control function.....	97
Appendix 6-1	User's authority setting.....	97
Appendix 6-2	User/guest login	98
Index of Terms.....	99

1 Prior to use

1-1 Operating precautions



DANGER

	<p>■ Do not wet the AC adapter. That may cause an electric shock, short-circuiting or failure.</p>
	<p>■ Do not handle the balance or AC adapter with wet hands. That may cause an electric shock, short-circuiting or failure.</p>
	<p>■ Do not use the balance in a wet location. That may cause an electric shock, short-circuiting or failure.</p>
	<p>■ Do not connect to the AC adapter cord or communication cable with its connector or jack being wet. That may cause an electric shock, short-circuiting or failure.</p>
	<p>■ Do not use the balance in a dusty location. That may cause dust explosion or fire. That may cause short-circuit or malfunction of the balance.</p>
	<p>■ Do not use the balance in explosive atmosphere. That may cause explosion or fire. Please order our explosive-proof balances to weigh in such a hazardous area.</p>
	<p>■ Never disassemble or modify the batteries. Make sure you insert batteries with the positive and negative poles correctly inserted, and be careful of short circuits. Such mishandling could damage the batteries, or cause the balance to fail.</p>
	<p>■ Obey the MSDS. Measuring dangerous materials such as flammable liquid could cause an explosion or fire.</p>

WARNING

	<p>■ Do not disassemble or modify the product. Doing so could result in injury, electric shock, fire and other accidents or failures. For inspection and adjustment, contact the retailer from whom the product was purchased.</p>
	<p>■ Do not move the product with a sample to be weighed set on the balance. That may cause the sample to fall from the weighing pan, leading to a bodily injury or destruction of the sample.</p>
	<p>■ Do not route the AC cord across passages. The cord could be tripped on by a passerby and the balance could fall down and break or injure someone.</p>
	<p>■ Do not use the product on an unstable table or a place that is subject to vibration. That may cause the sample to fall from the weighing pan, leading to a bodily injury or destruction of the sample. Besides inaccurate weighing may result.</p>
	<p>■ Do not place an unstable sample on the weighing pan. The sample may fall down, giving rise to a danger. Put an unstable sample in a container (tare) before weighing it.</p>
	<p>■ Only use the specified power supply. Using any power supply other than that specified could cause overheating, fire or failure.</p>
	<p>■ Do not bring the balance by holding the windshield. The main body could drop and break down or injure someone. Make sure to hold the main body to bring the balance.</p>



 **WARNING**

	<p>■ Do not use the product in an abnormal condition. If it should happen that an abnormal event such as smoking or unusual odor occurs, ask the store where you purchased the product or our sales department for repair. Keeping using the product may result in an electric shock or fire. In addition, do not ever try to repair it for yourself, or very dangerous situation is likely to occur.</p>
	<p>■ Only use the dedicated AC adapter. Use of other types of power or adapters may result in heat generation or malfunction of the balance.</p>

 **CAUTION**

	<p>■ Do not apply excessive force to or impact the balance. Doing so could damage or result in failure of the balance. Carefully place samples on the balance.</p> <p>■ Do not use volatile solvents. The main unit could deform. Wipe the main unit using dry cloth or a cloth moistened with a small amount of neutral detergent.</p>
-----------------------------------------------------------------------------------	---------------------------------------------------------------------------------------------------------------------------------------------------------------------------------------------------------------------------------------------------------------------------------------------------------------------------------------------------------------

Note

	<p>■ Do not install the balance in a place where it is directly exposed to airflow from air-conditioning or heating equipment. Due to changes in the ambient temperature, the balance could fail to accurately weigh samples.</p> <p>■ Do not install the balance in a place exposed to direct sunlight. The internal temperature of the balance could rise and the balance could fail to accurately weigh samples.</p> <p>■ Do not install the balance where the floor is soft. When a sample is placed on the balance, the balance could slant and fail to accurately weigh samples.</p> <p>■ Do not install the balance in a place where the ambient temperature or humidity change significantly. The balance could fail to accurately weigh samples.</p>
	<p>■ Adjust (calibrate) the balance when it is installed or relocated. Failure to do so might result in measurement errors. To ensure accurate measurements be sure to adjust (calibrate) the balance.</p> <p>■ Check for an error periodically. Use environment and chronological change cause an error in measured value, leading to an inaccurate measurement.</p> <p>■ Unplug the AC adapter from the receptacle when the balance is not going to be used for a long period of time. Unplug the balance from the receptacle to save energy and prevent degradation.</p> <p>■ Always adjust the level of the balance before use. A tilted balance generates errors which might cause inaccurate weighting.</p>
	<p>■ For proper disposal This product including accessories may not be disposed of in domestic waste in conformance with the specific requirements in your country, such as the European Directive 2012/19/EU on waste electrical and electronic equipment(WEEE). When you dispose of this product, please contact your local authorities or dealer and ask for the correct method of disposal.</p>

1-2 For more accurate measurement

To make more accurate measurement, it is necessary to lessen error-causing factors in measurement to the extent possible. Error-causing factors include not only an instrument error and performance of the balance itself but also the nature and condition of a specimen, measuring environment (vibration, temperature, humidity, etc.) and the like. These factors will directly affect measurement result in the case of a balance with high resolution capability.

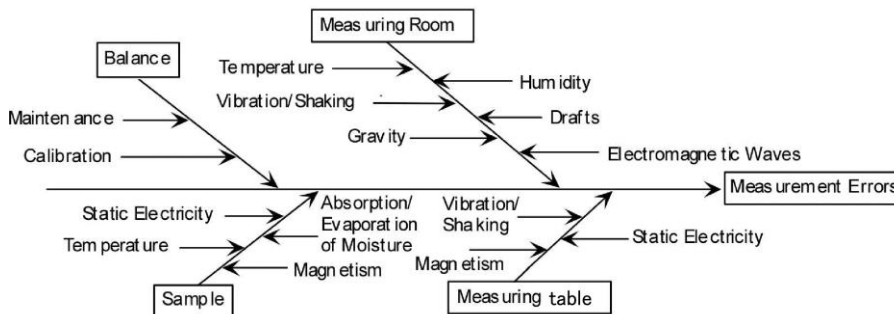

Measurement Errors

1-2-1 Precautions related to measuring environment

Temperature/humidity/atmospheric pressure	→ Try to keep the room temperature constant to the extent possible in order to avoid condensation and indication drift due to change in temperature. → Low humidity is likely to cause generation of static electricity, resulting in inaccurate measurement.
Vibration/shaking	→ It is preferable to locate a measuring room on the first floor or the basement. The higher the room is, the larger the vibration and shaking become. Therefore, a highly located room is not suitable for measurement. Rooms near the railway or road side should also be avoided.
Air draft	→ Places directly exposed to air current from an air-conditioner or to direct sun generate abrupt temperature change and resultantly cause unstable weight indication, and therefore, should be avoided.
Gravity	→ The latitude and altitude of a measuring location differentiate the gravity that affects a specimen, giving a different weight indication to the same specimen.
Electromagnetic wave	→ At a location where a strong electromagnetic wave generating object is in the proximity of a balance, the balance is affected by the electromagnetic wave, making the balance unable to indicate accurate weight, and therefore, such a location should be avoided.

1-2-2 Precautions related to measuring table

Vibration/shaking	→ Vibrations during measurement destabilizes the indication of measurement value, leading to inability to make accurate measurement. And so use of a measurement table that is robust and hardly affected by vibration is required (a vibration-proof structured table or concrete or stone-made table is suitable). In addition, placing a sheet of soft cloth or paper under the balance causes shaking or makes keeping horizontal attitude difficult, and therefore should be avoided. → The measurement table should be installed in a position free from vibration to the extent possible. A corner rather than the center of a room is less affected by vibration and therefore more suitable for installation of the balance.
Magnetism/Static electricity	→ Use of the balance on the table that is subject to magnetism or static electricity should be avoided.

1-2-3 Precautions related to a specimen

Static electricity	→ In general, synthetic resin- and glass-made specimens are high in electric insulation, and so easily charged electrically. Weighing an electrically charged specimen makes the indication value unstable, reducing the reproducibility of the test result. Therefore, neutralize an electrically charged specimen before measurement.
Magnetism	→ Specimens affected by magnetism show different weight in a different position of the weighing pan, reducing the reproducibility. When weighing a magnetized specimen, either eliminate the magnetism from the specimen or place a setting plate on the weighing pan to distance the specimen from the weighing mechanism of the balance so that the mechanism may not be affected by the magnetism.
Moisture absorption/ Evaporation	→ Measuring a moist or evaporating (vaporizing) specimen increases or decreases the indication value of the balance continuously. When this is the case, put the specimen in a container equipped with a small mouth and closely seal the mouth before measurement.
Specimen temperature	→ Difference in temperature between the specimen and the windshield interior generates convection flow within the windshield, causing a measurement error. When the specimen temperature is excessively high or low, allow the specimen temperature to stabilize at the room temperature before measurement. Also, to prevent the convection flow from arising within the windshield, make the windshield interior temperature equal to the room temperature before measurement. → Measurer's body temperature also affects measurement result. Handle a specimen with tweezers instead of directly holding it with fingers and refrain from putting your hands directly in the windshield during measuring operation.



1-2-4 Precautions related to the main unit of a balance

Operating precautions	→ A dust cover, if equipped, for the balance may possibly make the weight indication unstable due to static electricity charged on the cover at a low humidity. When this is the case, wipe the cover with wet cloth or use antistatic agent or use the balance with the cover removed. → For more stable measurement, it is recommended to energize the balance for longer than 30 minutes and load the balance a few times with a weight equivalent to the weighing capacity before measurement.
Adjustment	→ Calibrate the balance periodically with an external adjustment weight or internal adjustment weight. For the sake of precise calibration, use an external adjustment weight weighing nearly equal to the weighing capacity of the balance. → Energize the balance for longer than 30 minutes and load the balance a few times with a weight equivalent to the weighing capacity before adjustment. → Adjustment is also needed in the following cases: When using the balance for the first time, When using the balance after a long period of non-use, When changing a place of installation, and When there was a large change in temperature, humidity or atmospheric pressure.
Maintenance	→ Attachment of dirt such as powder or liquid to the weighing pan or pan base will cause measurement error or unstable weight indication. For that reason, frequent cleaning of the balance is required. In cleaning the balance, take care for the dust or liquid not to enter into the balance.

1-3 Check for the articles contained in the box

The package box contains the following;

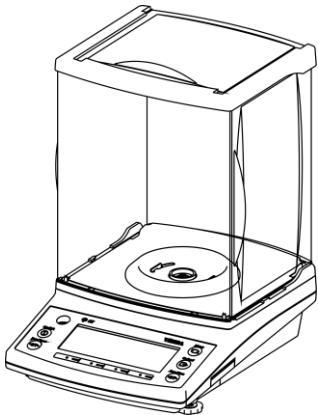
If anything missing or broken should be found, please inform the store where you purchased the product.

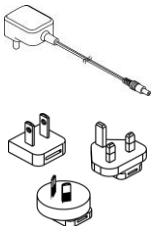
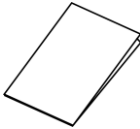
<p>① Main unit: 1</p> 	<p>② Pan base: 1</p> 	<p>③ Pan: 1</p> 
<p>④ AC adapter: 1 AC adapter plug set: 1</p> 	<p>⑤ Operation manual: 1</p> 	

1-4 Name and function of each section

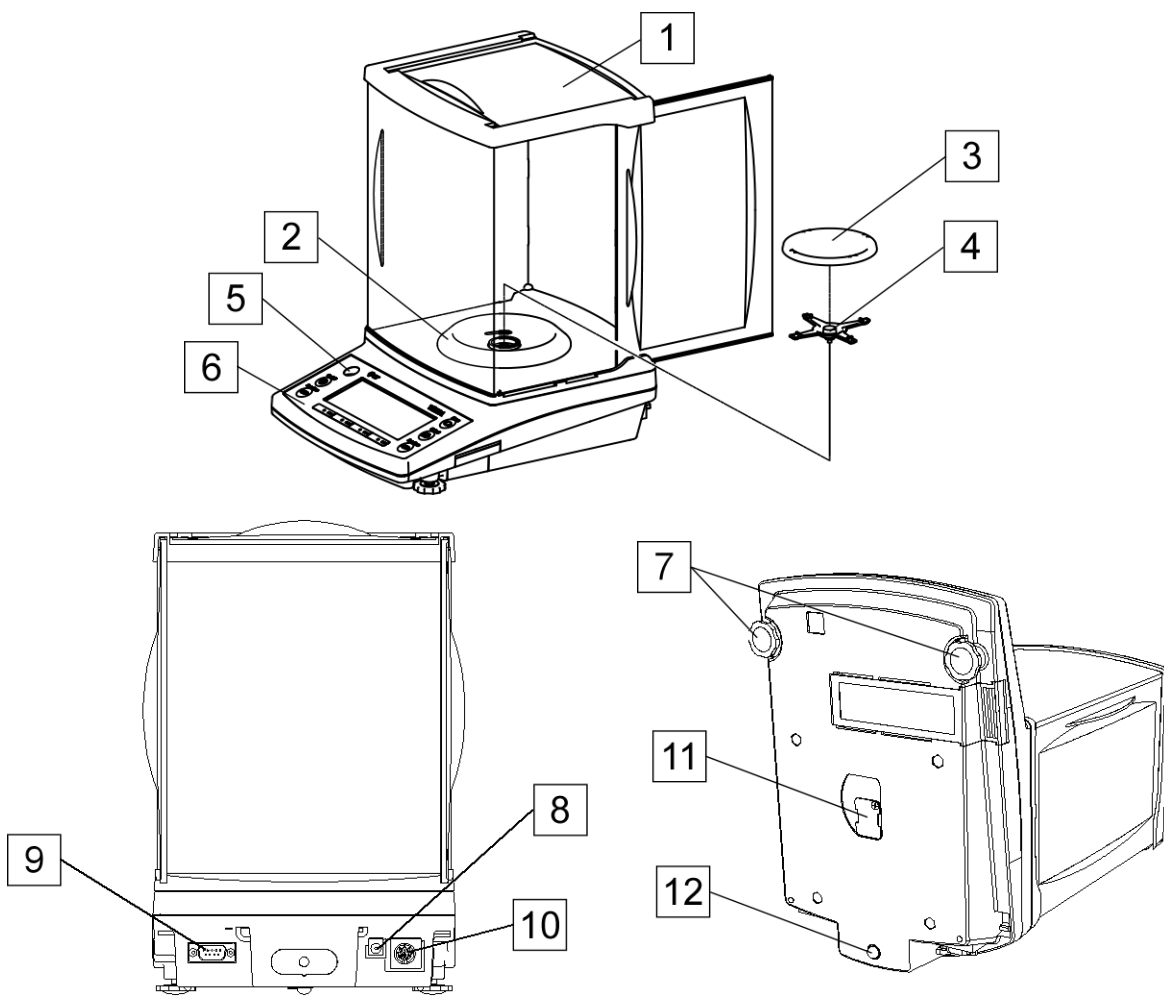

1	Windshield	2	Windshield ring
3	Pan	4	Pan base
5	Level	6	Display and Operation keys
7	Adjuster (Adjustable leg)	8	AC adapter jack
9	RS-232C connector (D-sub 9 pin male)	10	Connector for peripheral devices (DIN8P) * Replace the connector cap when not connected.
11	Cover of hanging hook	12	Fixed leg

1-5 Assembling and installation of the product

Note

After the balance has been moved, open the windshield door to allow it to adapt to the ambient temperature for stable measurement.
In addition, allow five minutes after turning on the power for the balance to warm up.

1-5-1 Assembling the balance

1 Attach the Pan base and Pan.

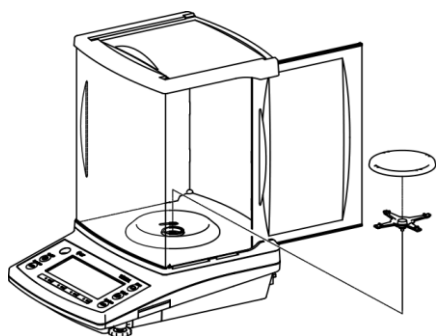

2 Put the AC adapter plug to the AC adapter, then connect the AC adapter.

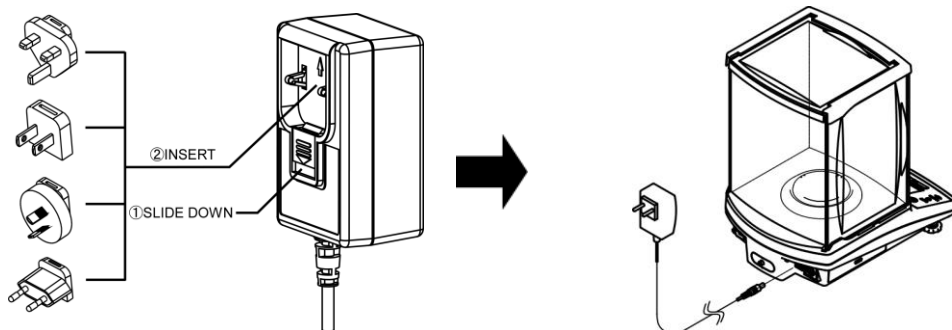

1-5-2 Level

1 Release the transportation lock of the adjuster.

At the time of shipment, the adjusters provided at the two corners of the bottom are locked. Turn them in the direction shown in the figure on the left to loosen them.

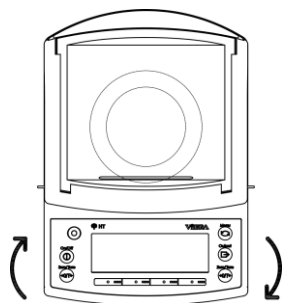

2 Level the balance.

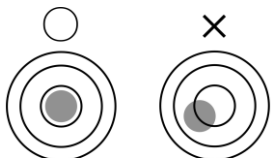

Turn the adjusters so that the bubble enters in the center circle

- (1) While watching the level, turn the adjusters provided on the bottom to level the main unit.
- (2) Bring the bubble enters in the center circle as shown in the figure on the left.
- (3) When having leveled the main unit, slightly push the four corners of the balance to make sure that there is no rattle.

Turn the adjusters as shown below depending on the position of the bubble in the level.

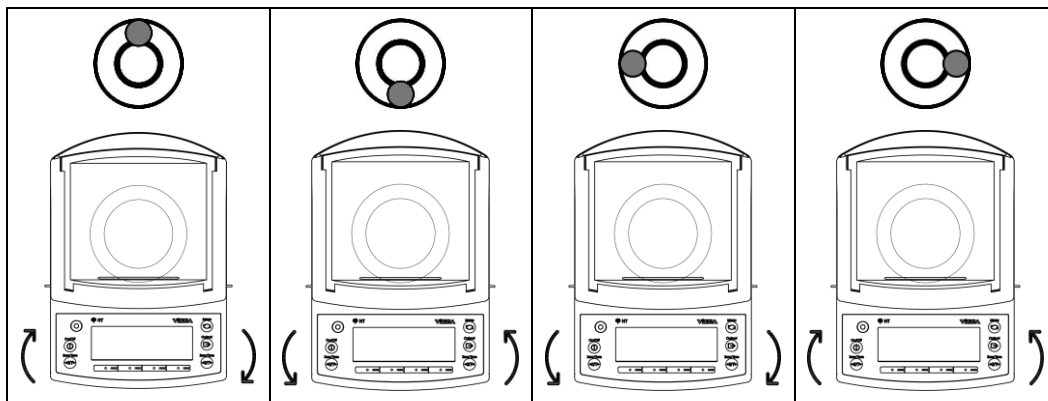

1-6 Description of the operation keys

1-6-1 Basic

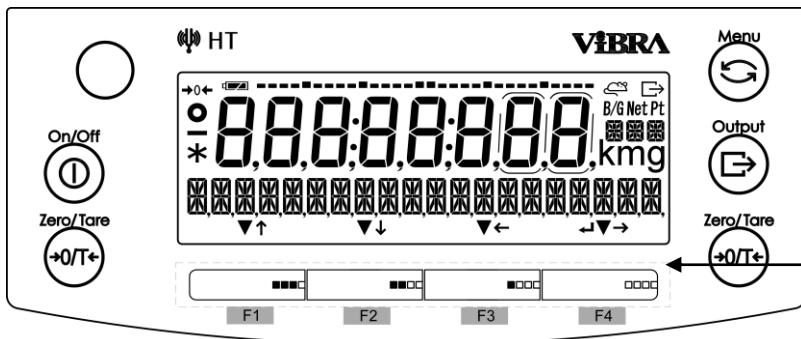

Reference
 These keys are called [F] keys or [F1]-[F4] key in this manual as a matter of convenience, while there are not such indications around them.

No	Key	Name of key	Performance
1		[On/Off]	Turns on and off the power for the balance. On: Push the key, Off: Push the key long
2		[Menu]	Used for calling/exiting the setting menu. Used for canceling the setting value selection and going back to the measuring mode.
3		[Output]	Use for data outputting.
4		[Zero/Tare]	Use for zero-point adjustment/tare subtraction.
5		[F1] ([F] key)	< ▼ > : Use for selecting the mode, function and item. < ↑ > : Use for moving up to the menu/item selections, or use for incrementing the numeric values.
6		[F2] ([F] key)	< ▼ > : Use for selecting the mode, function and item. < ↓ > : Use for moving down to the menu/item selections, or use for decrementing the numeric value.
7		[F3] ([F] key)	< ▼ > : Use for selecting the mode, function and item. < ← > : Use for moving to the upper menu layer, or use for selecting the digit to change.
8		[F4] ([F] key)	< ▼ > : Use for selecting the mode, function and item. < → > : Use for moving to the lower menu layer, or use for selecting the digit to change. < ↵ > : Use for entering/executing the selected menu/item/value, or use for returning to the setting menu/measuring mode.

Reference The [F] keys on which < ↑ >, < ↓ >, < → >, < ← >, < ↵ > or < ▼ > are displayed above are valid. Shortcuts for various modes/functions can be assigned to [F] keys. Please refer to “8-2 Shortcut setting for accessing various measuring modes” and “8-3 Free key setting”.

1-6-2 Setting value and numeric value inputting

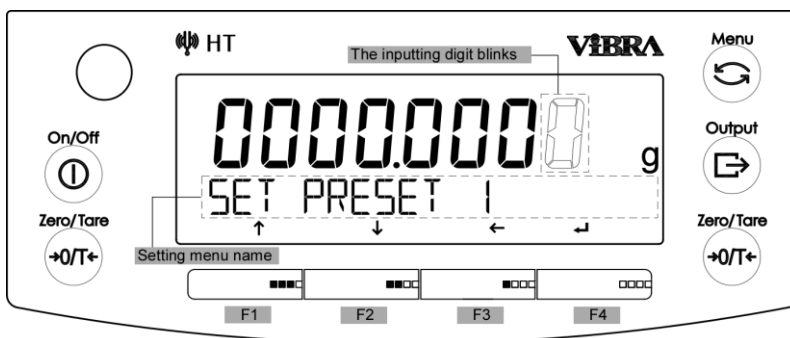

No	Key	Name of key	Performance
1		[Menu]	Cancel the input value and go back to the setting menu.
2		[Zero/Tare]	Input a decimal point < . > in the "Multiplied by Coefficient mode" and "Specific gravity mode".
3		[Output]	Use for changing polarity < +/->.
4		[F1] ([F] key)	< ↑ > : Use for incrementing the numeric values. < 0 → 1 → 2 → ... → 9 → 0 >
5		[F2] ([F] key)	< ↓ > : Use for decrementing the numeric values. < 0 → 9 → 8 → ... → 1 → 0 >
6		[F3] ([F] key)	< ← > : Use for selecting the digit to change.
7		[F4] ([F] key)	< ↵ > : Use for entering the value.

Reference The [F] keys on which < ↑ >, < ↓ >, < → >, < ← >, < ↵ > or < ▼ > are displayed above are available.

1-7 How to interpret the display

1-7-1 Description of segment.

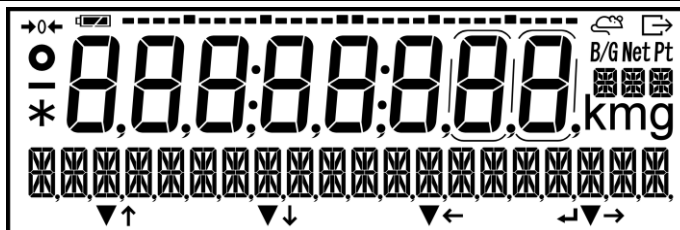

No	Mark	Name	Description
1	—	Minus	Indicates the negative weight value and numeric.
2	○	Stable mark	<ul style="list-style-type: none"> - When displayed: The balance is in the stable condition. - When not displayed: The balance is not in the stable condition.
3	→0←	Zero point	Indicates the zero point.
4	8	7 segment	<ul style="list-style-type: none"> - Indicates the weight value - Indicates the simplified character.
5	🔋	Battery mark	Display when the balance is powered by batteries.
6	➡	Output	Displayed when data are being output to external devices.
7	B/G	Gross weight	Indicates gross weight.
8	Net	Net weight	<ul style="list-style-type: none"> - Indicates that the tare weight is being subtracted. - Indicates the preset tare weight is being subtracted.
9	Pt	Preset tared weight	Indicates the preset tare weight is being subtracted.
10	g	Gram	Indicates the gram unit.
11	mg	Milligram	Indicates the milligram unit.
12	ⓧⓧⓧ	16 segment message 16 segment unit	<ul style="list-style-type: none"> - Displays various messages. - Indicates the various units.
13	↑ ↓ → ← ↙ ▼	Operation of the [F] key	Displayed when the [F1] – [F4] keys are effective.
14	:	Colon	Displayed when the date and time display.
15	*	Asterisk	<ul style="list-style-type: none"> - Lights in the standby status. - Indicates addition available status when the adding function is used.
16	Bar graph	<ul style="list-style-type: none"> - Indicates the present total amount relative to the weighing capacity defined as 100%. - Indicates the state of span adjustment / calibration with internal weight.
17	Ⓜ	Auxiliary scale interval	Lights up only when the auxiliary scale interval is displayed.



No.17 is indicated only on the verified balance.

1-7-2 LCD character font

■7-segment

A	B	C	D	E	F	G	H	I	J	K	L	M	N	O
A	b	C	d	E	F	G	H	I	J	K	L	M	N	O
P	Q	R	S	T	U	V	W	X	Y	Z	c	comma	point	
P	q	r	s	t	u	v	w	x	y	z	c	,	.	
1	2	3	4	5	6	7	8	9	0	space	minus / hyphen			
1	2	3	4	5	6	7	8	9	0	-	-			

■16-segment

A	B	C	D	E	F	G	H	I	J	K	L	M	N	O
A	B	C	D	E	F	G	H	I	J	K	L	M	N	O
P	Q	R	S	T	U	V	W	X	Y	Z				
P	Q	R	S	T	U	V	W	X	Y	Z				
b	c	d	g	l	m	n	o	t	w					
b	c	d	g	l	m	n	o	t	w					
1	2	3	4	5	6	7	8	9	0					
1	2	3	4	5	6	7	8	9	0					
asterisk	slash	left arrow	right arrow	space	plus	minus / hyphen								
*	/	←	→		+	-								
comma	point	percent	Degree Celsius											
,	.	%	°C											

2 Basic usage

2-1 Turning on/off the power, and checking for the operation

1 Turn on the power for the balance.

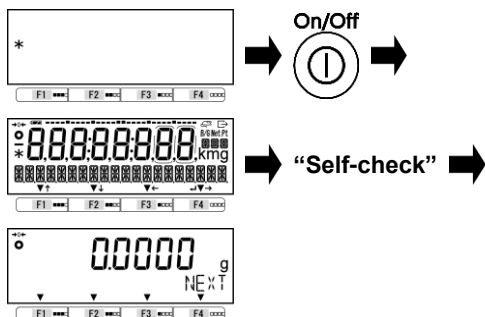

Connect the included AC adapter to the balance.

When the AC adapter is plugged in, the balance enters the standby state and an asterisk < * > appears.

Push [On/Off] key.

All displays on the LCD lights, followed by the self-check of the balance. During the self-check, the LCD display automatically changes.

Completion of the self-check is followed by the weight mode.

Note Do not push any key during the self-check.

2 Balance operation check.

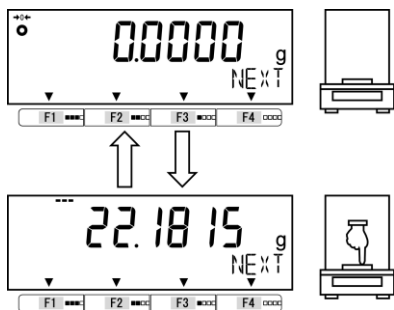

Press the weighing pan lightly to check if the indication changes.

3 Turn off the power for the balance.

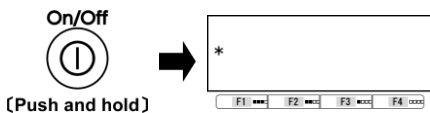

Push and hold [On/Off] key (About 2 seconds)

Reference	<p>(1) Pushing and holding [On/Off] key obtains the standby status from any operation status.</p> <p>(2) The balance starts up in the last measuring mode before it was switched off.</p>
<small>Legal Metrology</small>	<p>Verified balance always starts up in weighing mode.</p>

2-2 Zero-point adjustment

Adjusting the indication to zero is called "Zero-point adjustment".

1 Check the weighing pan.

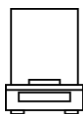

Make sure that nothing is placed on the weighing pan.

2 Execute "Zero-point adjustment".

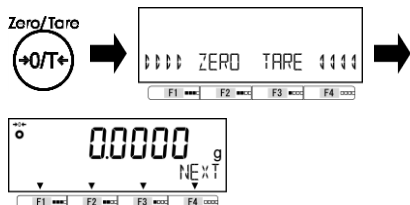

Push [Zero/Tare] key.

Displays become zero and the symbol "→0←" lights.

- (1) When a sample whose weight is over the "Zero-point adjustment range" is placed on the weighing pan, "tare subtraction" works instead of zero-point adjustment. (Refer to the "2-3 Weighing a sample placed on a container (tare)")
- (2) Stability waiting during the Zero-point adjustment can be set using the Setting menu <17 WT STABLE>.

Reference

Legal Metrology The setting of <17 WT STABLE> is not changeable and the balance always wait stability during the zero-point adjustment.

2-2-1 Zero-point adjustment range

There is a Zero-point adjustment range (limit) in this product. When the weighing load (gross) is below the lower limit, "Zero-point adjustment" is not executed. When the weighing load (gross) exceeds the upper limit, not "Zero-point adjustment" but "Tare-subtraction" is executed.

Model	Lower limit (g)	Upper limit (g)
HT84(R)CEN	-1.2000	1.2000
HT124(R)CEN	-1.8000	1.8000
HT224(R)CEN	-3.3000	3.3000

2-3 Weighing a sample placed on a container (tare)

When weighing a sample to be weighed with the object placed on a container (tare), the weight of the container must be subtracted from the total weight to get the actual weight of the object to be weighed. This is called “tare subtraction” or “tare”.

1 Place a container on the weighing pan.



The weight of the container is displayed.

2 Perform tare subtraction.

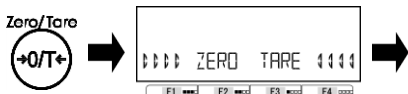

Push [Zero/Tare] key.

The indication changes to zero and the < Net > symbol lights.



3 Check the tare weight.

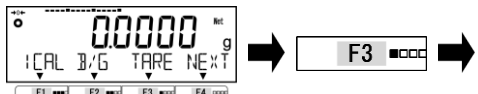

The tare weight can be checked by operating “Free keys” if the <TARE> is assigned to the Free key.

Refer to “8 Controlling and adjustment functions” for setting the Free keys.

Push [F1-F3] key on which <TARE> is displayed above.

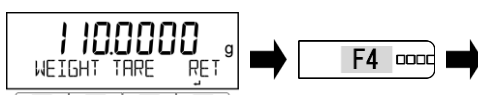

The tare weight is displayed on the display, then push [F4] < ← > key to return to the measuring mode.



4 Put the sample on the tare.



The net weight of the sample is displayed.

5 Clear the tare weight data.

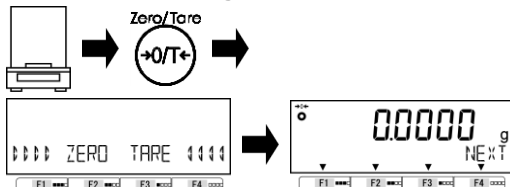

Remove the sample and tare on the weighing pan, then push [Zero/Tare] key.

Therefore, the indication becomes zero and < Net > indication disappears.

- (1) Performing the tare narrows the weighing range as much as the amount of the tare weight mass (tare weight).
Weighable range = weighing capacity - tare weight

- (2) Stability waiting during the tare can be set using the Setting menu <17 WT STABLE>.

Legal Metrology The setting of <17 WT STABLE> is not changeable and the balance always wait stability during the tare weight subtraction.

Reference

- (3) When using a tare whose tare weight is already known, the tare can be performed in advance by inputting its tare weight (preset tare). For its setting method, refer to “5 User information setting”.
- (4) When turning on the power placing a tare that exceeds the initial zero adjustment range at the time of power supply, the tare subtraction is executed.

Legal Metrology This operation is not valid.

- (5) Tare weight can be output at “Step 3 Check the tare weight” by pushing [Output] key. Check “External input/output functions” to refer the output setting.

2-4 Weighing the additional sample

Weigh the first sample and the additional sample separately.

1 Place a sample to be weighed.



The mass of the sample to be weighed placed is indicated.

2 Perform the tare.

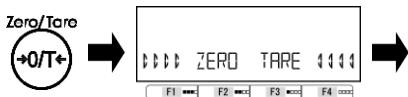

Push [Zero/Tare] key.

The indication changes to zero and the < **Net** > symbol appears.



3 Place an additional sample to be weighed.



The mass of the added sample alone is indicated.

2-5 Basic operation

Reference

Shortcuts for various modes/functions can be assigned to [F] keys. Please refer to "8-2 Shortcut setting for accessing various measuring modes" and "8-3 Free key setting".

2-5-1 Hierarchy of a setting menu

The setting menu of this product is divided into four, from the first layer to the third layer and for various settings.

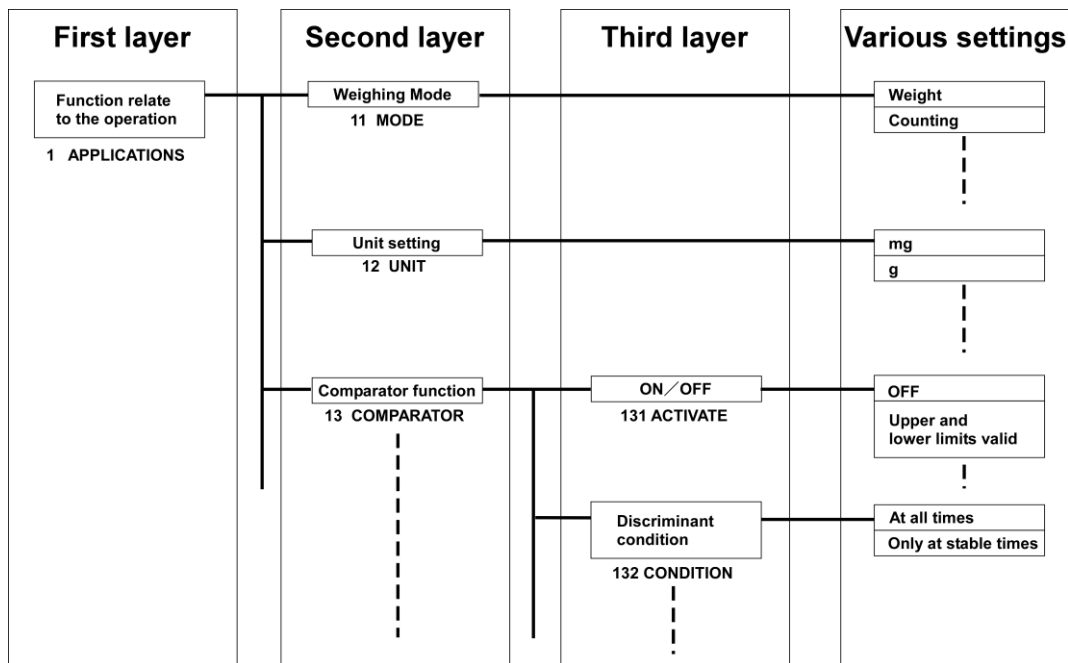

2-5-2 Operation of the setting menu

To perform settings for various functions from the state of weighing, chiefly execute the following procedure.

- Go to the menu item to set

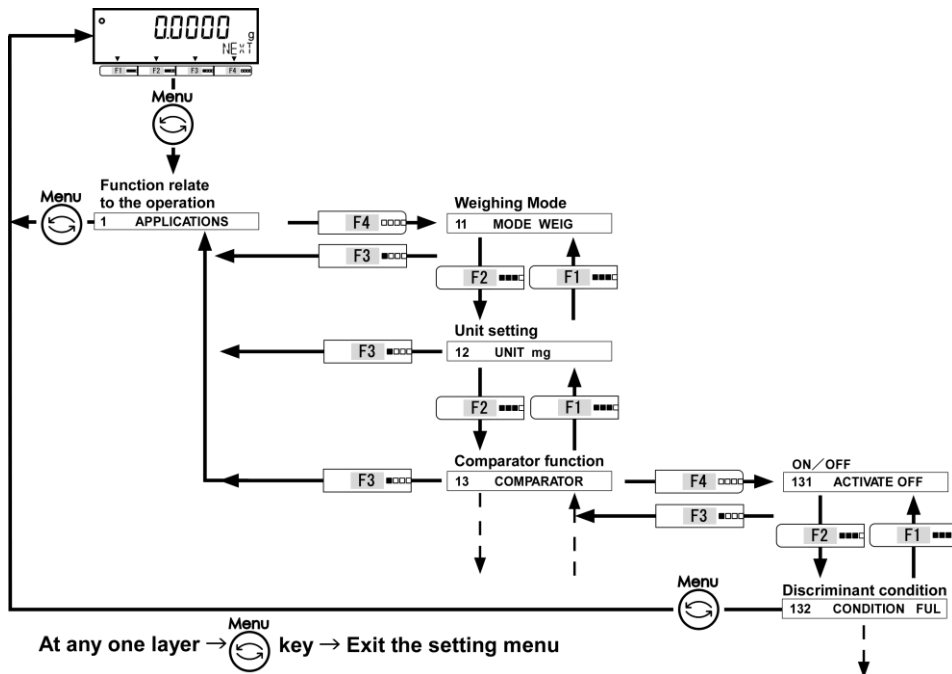

- Select the setting value and execute/fix.

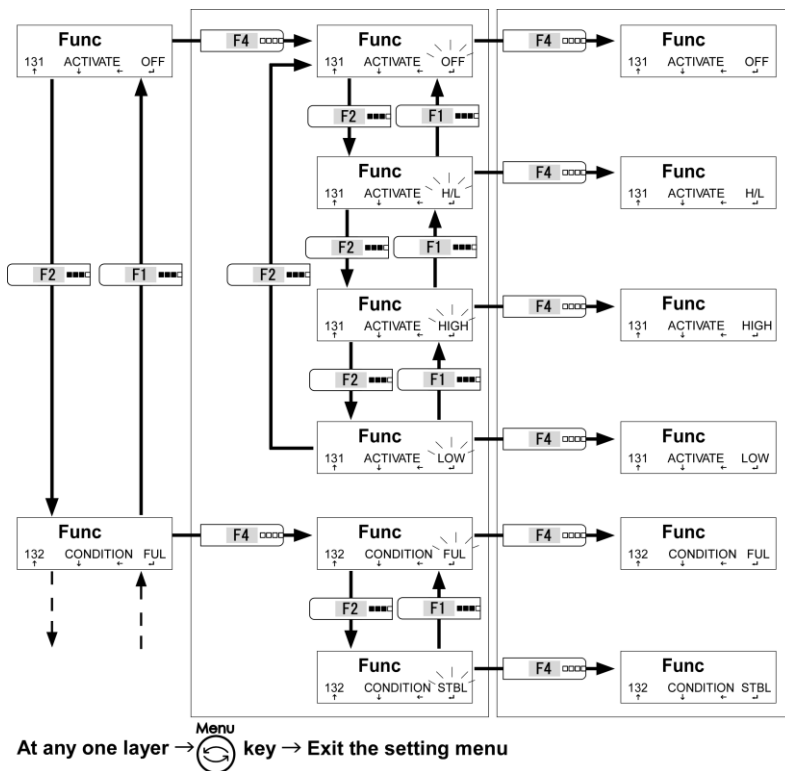

2-5-3 Numeric value input

Input upper/lower limit, reference weight, unit weight, preset tare weight, coefficient, specific gravity of the liquid, date/time and ID/password at each mode.

Reference

Numeric value inputting is limited to eight digits at a maximum.

Ex) When inputting “-5.4321” in “Multiplied by Coefficient mode”.

1 Input “-”.

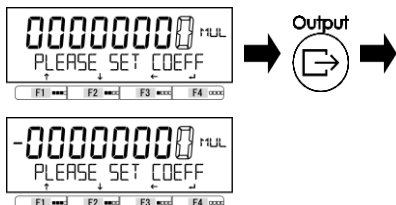

Push [Output] key to change the polarity to “-”.

2 Input “1”.

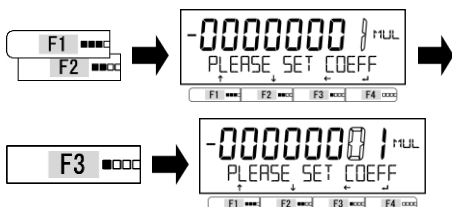

The digit for inputting is blinking.
Push [F1, F2] key to increment/decrement the digit to “1”.
Push [F3] key to input the next digit.

3 Input “2, 3, 4, 5”.

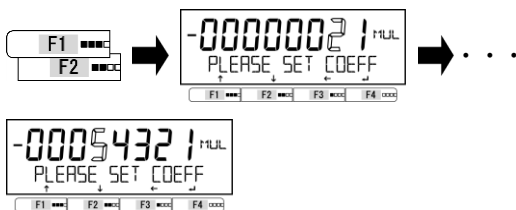

Input “2, 3, 4, 5” by the procedure above.

4 Input “.”.



Push [Zero/Tare] key to input “.” on the immediately right of the blinking digit.

5 Fix the input value.

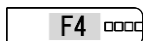

Push [F4] key to fix the input value.

The coefficient “-5.4321” is saved on the balance.

Reference

“-” and “.” cannot be input in ID or Password setting.
cf. “8-5-1 Balance ID setting”

2-5-4 [F] key switching at each measuring mode

You can switch the measuring mode, or select and set the function, by operating the [F] keys at each measuring mode.

This chapter shows the [F] keys switching by pushing the [F4] key.















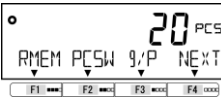
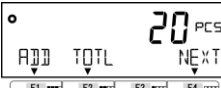

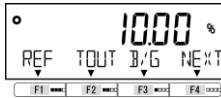
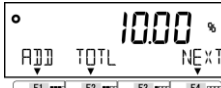
Refer to “3 Function related to the operation” for the [F1-F3] keys operation.

Legal Metrology

“Multiplied by Coefficient mode” is not available for verified balance.

Reference

- (1) In weighing mode, <<F1-F6>> (Free keys) are assigned to [F] keys as described follow; <<F1>> and <<F4>>: [F1] key, <<F2>> and <<F5>>: [F2] key, <<F3>> and <<F4>>: [F3] key. Please take care not to confuse <<F1-F4>> to [F1-F4] keys.
- (2) Refer to “8 Controlling and adjustment functions” for assigning “Free keys” and “Shortcuts” to [F] keys.



<p>Weighing mode</p> <p><<F1-F3>> (Free key)</p> <p>- For models with internal calibration weight (HTRCEN)</p>  <p>- For models without internal calibration weight (HTCEN)</p>  <p><<F4-F6>> (Free key)</p>  <p>Comparator setting menu</p>  <p>Shortcut</p>  <p>Return to the first menu item</p>	<p>Counting mode</p> <p>Counting mode menu</p>  <p>Adding execution, Sum total</p>  <p>Comparator setting menu</p>  <p>Shortcut</p>  <p>Return to the first menu item</p>	<p>Percentage mode</p> <p>Percentage mode menu</p>  <p>Adding execution, Sum total</p>  <p>Comparator setting menu</p>  <p>Shortcut</p>  <p>Return to the first menu item</p>	<p>Multiplied by Coefficient mode</p> <p>Multiplied by Coefficient mode menu</p>  <p>Adding execution, Sum total</p>  <p>Comparator setting menu</p>  <p>Shortcut</p>  <p>Return to the first menu item</p>
<p>Specific gravity mode (Solid)</p> <p>Solid specific gravity mode menu</p>  <p>Shortcut</p>  <p>Return to the first menu item</p>	<p>Specific gravity mode (Liquid)</p> <p>Solid specific gravity mode menu</p>  <p>Shortcut</p>  <p>Return to the first menu item</p>		

3 Functions related to the operation

Settings to change the balance operations.

3-1 Hierarchy of functions related to the operation

For verified balance:

 - Gray shaded items () are not indicated;

- <17 WT STABLE> is not indicated and fixed to be <ON>.

★: Initial setting value

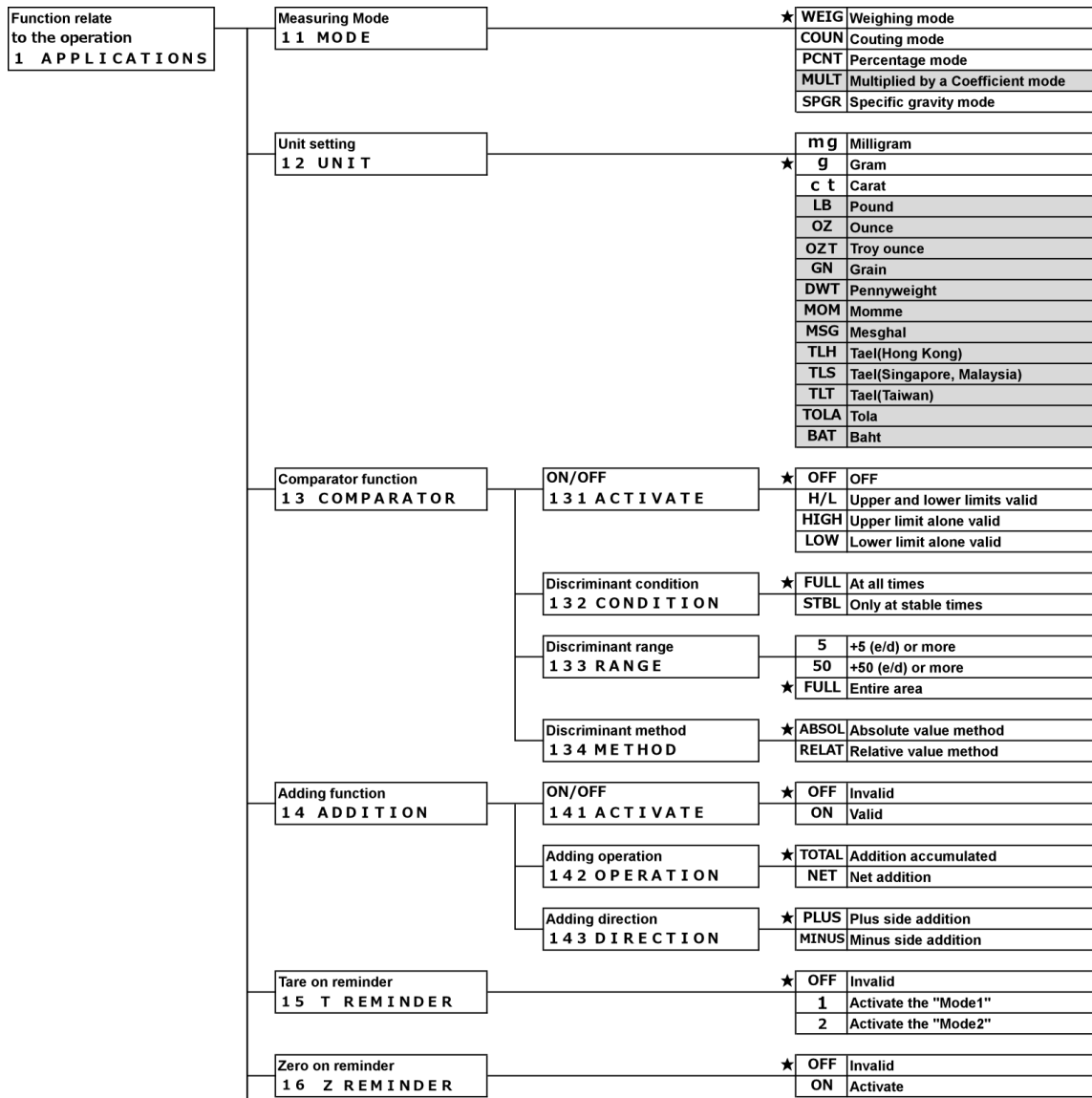

Stability waiting 1 7 WT STABLE	OFF	Invalid
	★ ON	Valid
Bar graph indication 1 8 BARGRAPH	OFF	Invalid
	★ ON	Valid
Back Light 1 A BACKLIGHT	OFF	Invalid
	3MIN	3 minutes
	5MIN	5 minutes
	10MIN	10 minutes
	30MIN	30 minutes
	★ ON	Always ON
Auto power-off 1 B AUTO OFF	★ OFF	Invalid
	3MIN	3 minutes
	5MIN	5 minutes
	10MIN	10 minutes
	30MIN	30 minutes
Simplified SCS 1 C SIMPLE SCS	★ OFF	Invalid
	ON	Valid

3-2 Various measuring modes of the balance

Reference

Refer to "6 External input/output functions" to output the measuring data to other devices.

3-2-1 Weighing mode

Weighing mode is the basic mode for weighing.

Reference

Various functions can be used with weighing mode by pushing the "Free key". Please refer to "8-3 Free key setting".

1 Select the weighing mode.

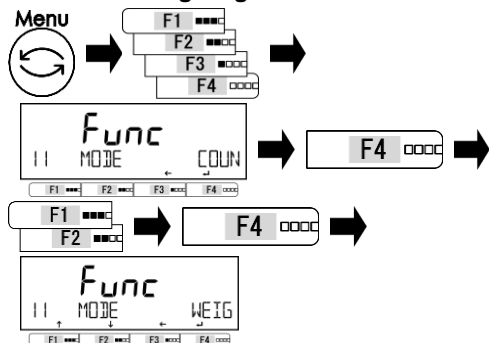

Push [Menu] key, then push [F1-F4] keys to go to <11 MODE>.

Push [F4] key to change the setting value.

Push [F1/F2] key to select.

WEIG : Weighing mode

Push [F4] key to fix.

2 Exit the setting menu.

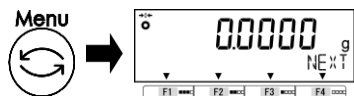

Push [Menu] key to shift to the weighing mode.

3 Execute tare subtraction

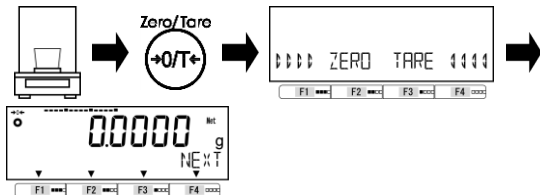

Place the container on the weighing pan if necessary.

Push [Tare] key

Tare-subtraction is executed, then the indication changes to zero and the <Net> symbol lights.

4 Weigh the sample.



Place a container on the pan, execute tare-subtraction and place the sample. The weighing result is displayed.

3-2-2 Counting mode



This mode is not legal for trade.

Counting mode can count the number of items by placing the items for which sampling has been completed on the balance and dividing the total weight of those items by the recorded unit weight. There are two methods to input the unit weight;

- Actual value setting method: Place the specified number of samples on the balance to record the average unit weight.
- Numeric value setting method: Input numeric value of the unit weight by key operation.

1 Select the Counting mode.

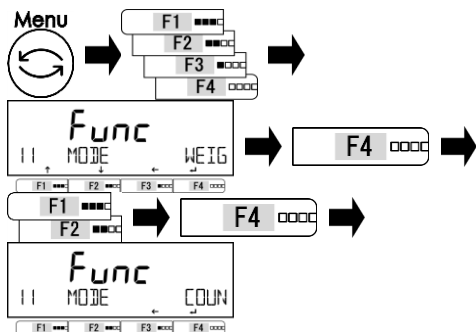

Push [Menu] key, then push [F1-F4] keys to go to <11 MODE>.

Push [F4] key to change the setting value.

Push [F1/F2] key to select.

COUN: Counting mode

Push [F4] key to fix.

2 Exit the setting menu.



Push [Menu] key to shift to the Counting mode.

3-2-2 (1) Actual value setting method

Place the specified number of samples on the balance to record the average unit weight internally.

1 Select whether or not employ the previous recorded unit weight.

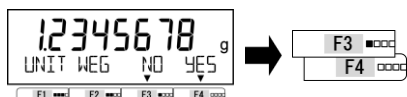

Push [F3/F4] key to select whether or not employ the previous data.

When there is no data record, this step is skipped.

Push [F3/F4] key to select.

NO: Change

YES: Not Change

When <OK> is selected, go to step 6.

2 Select the “number of samples mode”.

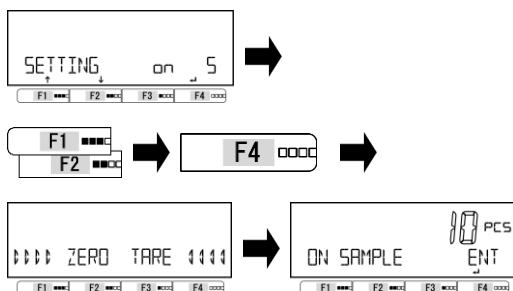

Push [F1/F2] key to select.

on 5: 5 PCS

on 10: 10 PCS

on 30: 30 PCS

on 50: 50 PCS

on 100: 100 PCS

on VAR: 1 – 999 PCS

PCSWGT: Numeric value setting method
See 3-2-2(2)

Push [F4] key to fix.

Zero-point adjustment or tare is set automatically.

3 Place the samples.

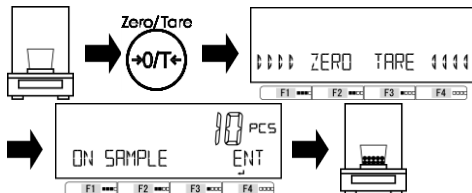

Place a container (tare) on the weighing pan.
Push [Zero/Tare] key.

Place the set number of samples on the weighing pan.

4 Record the unit weight.

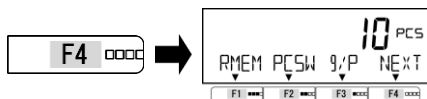

Push [F4] key to fix.

The unit weight is recorded.

5 Simple SCS method (When enabled).

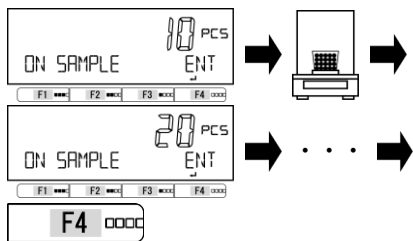

When <1C Simple SCS> is valid and <on 5> through <on 100> or <on VAR> is selected in step 2, Simple SCS method is activated and the sample counting indication blinks during this function.

Add more samples, then the number of samples and unit weight is automatically updated when the indication becomes stable. The number of additional samples can be up to two times the number of the samples of the latest update.

For example, when “10 PCS” is set, add 20 or less samples.

Repeat this step until the number of the samples has reached approximately one-fifth to one-half of the total numbers that you are intended to count.

Push [F4] key to fix the updated unit weight.

6 Put samples in place to count them.

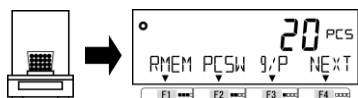

Place the samples.

Count result is displayed.

- (1) When <on VAR> is selected in step 2, select the specified number of the sample among 1 to 999 by operating [F1/F2] keys.
- (2) When simple SCS is operating, if the weight of the samples is less than the “SCS weight” — 99 times of the minimum readability ($d \times 99$) —, <Add> blinks on the display and unit weight cannot be updated. In this case, add samples until <Add> indication disappears, or select the larger number of samples in step 2.

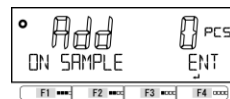

Reference

<64A REEADABILIT>	Readability d (g)	SCS weight (g)
1	0.0001	0.0099
2	0.0002	0.0198
5	0.0005	0.0495
10	0.001	0.099

- (3) When simple SCS is operating, if the number of the additional samples is larger than two times of the sample number of latest update, <Sub> blinks on the display and unit weight cannot be updated. In this case, decrease the number of additional samples.

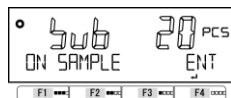

3-2-2 (2) Numeric value setting method

Input numeric value of the unit weight by key operation.

- 1 Select whether or not employ the previous recorded unit weight.



Push [F3/F4] key to select whether or not employ the previous data.

When there is no data record, this step is skipped.

Push [F3/F4] key to select.

NO: Change

YES: Not Change

When <YES> is selected, go to step 4.

Push [F1/F2] key to select.

PCSWGT: Unit weight value input

Push [F4] key to fix.

- 2 Select the "unit weight value input mode".

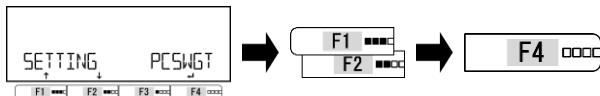

- 3 Input the unit weight.

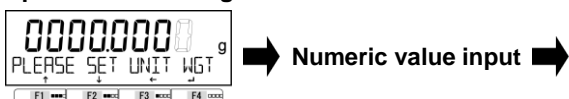

Input the unit weight.

Push [F4] key to fix.

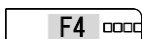

(Refer to "2-5-3 Numeric value input")

- 4 Put samples in place to count result.

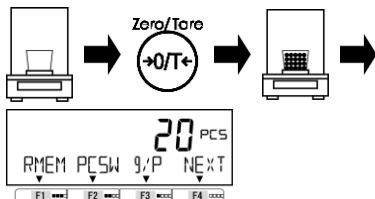

Place a container (tare) on the weight pan.

Push [Zero/Tare] key.

Place the samples.

The count result is displayed.

3-2-2 (3) Switching the display at Counting mode

- 1 Push [F1-F4] keys to switch the display.

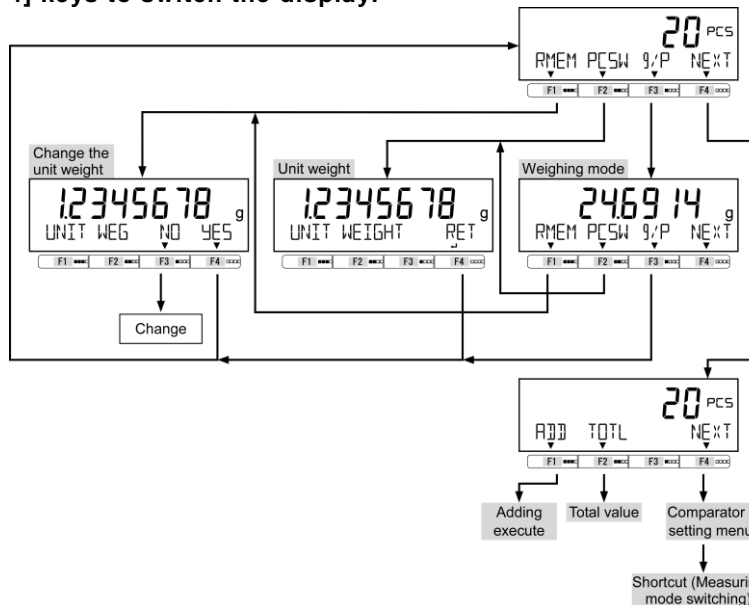

Reference

<ADD> and <TOTL> can be used when the <14 ADDITION> is "Valid".

3-3 Percentage mode

Legal Metrology

This mode is not legal for trade.

The weight of a sample to be weighed is indicated in percent relative to the reference weight. There are two methods to input the reference weight;

- Actual value setting method ([onW]): Place the reference weight on the balance to record the weight.
- Numeric value setting method ([NUM]): Input numeric value of the reference weight by key operation.

- (1) The lower limit of the reference weight is 0.01 g.
- (2) The minimum percent to be displayed is automatically set according to the recorded reference weight.

Reference	Readability (%)	Range of reference weight
	1	0.01 g ≤ Reference weight < 0.1 g
	0.1	0.1 g ≤ Reference weight < 1 g
	0.01	1 g ≤ Reference weight

1 Select the percentage mode.

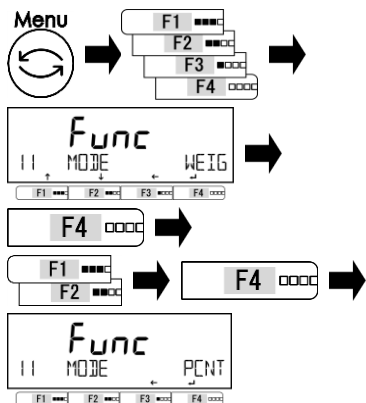

Push [Menu] key, then push [F1-F4] keys to go to <11 MODE>.

Push [F4] key to change the setting value.

Push [F1/F2] key to select.

PCNT : Percentage mode

Push [F4] key to fix.

2 Exit the setting menu.



Push [Menu] key to shift to the percentage mode.

3 Select whether or not employ the previous recorded reference value.

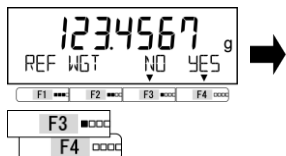

Push [F3/F4] key to select whether or not employ the previous data.

When there is no data record, this step is skipped.

Push [F3/F4] key to select.

NO: Change

YES: Not Change

When <OK> is selected, go to step 6.

4 Select the method of setting the reference value.

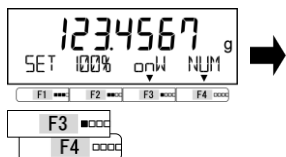

Push [F3/F4] key to select.

onW : Actual value

NUM : Numeric value

5 Save the reference value.

In the case of [onW].

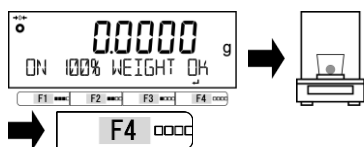

Place the reference weight on the balance.
Push [F4] key to record.

In the case of [NUM].

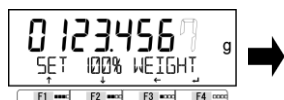

Input the reference value.
Push [F4] key to fix.

Numeric value input

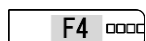

(Refer to "2-5-3 Numeric value input")

6 Weigh the samples.

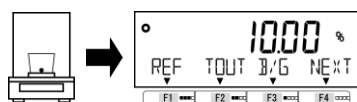

The ratio of the weight of the sample to the reference weight is indicated in percent.

3-3-1 Switching the display at percentage mode

1 Push [F1-F4] keys to switch the display.

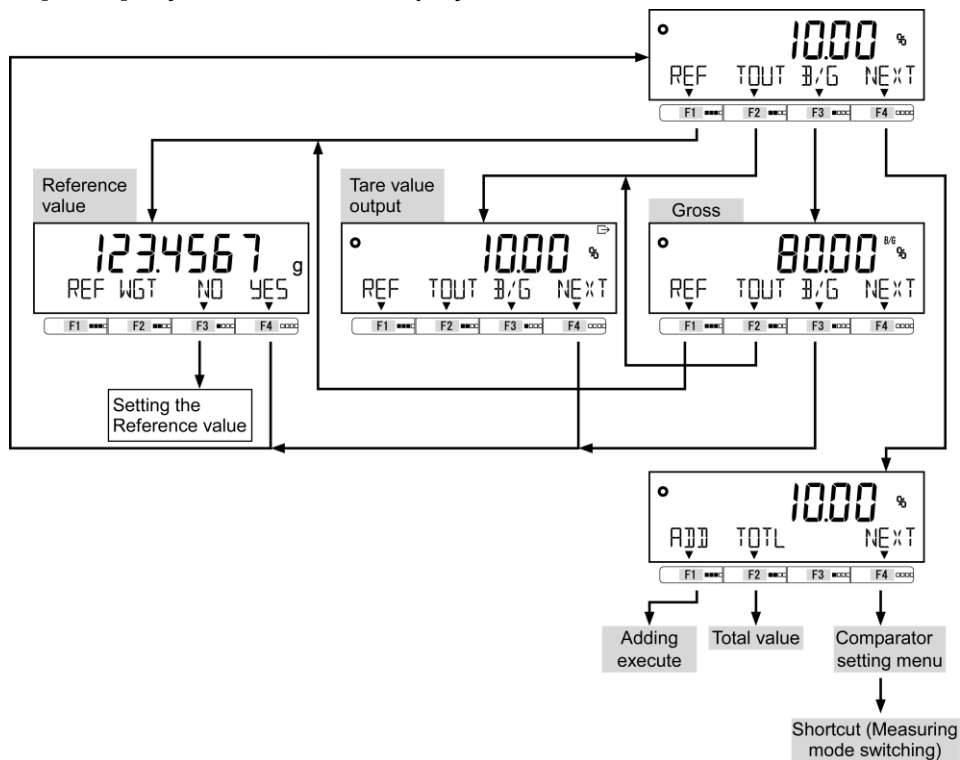

Reference

<ADD> and <TOTL> can be used when the <14 ADDITION> is activated.

3-4 Multiplied by Coefficient mode

Measured weight is multiplied by the preset coefficient, and the result be displayed.



This mode is not available for verified balance.

1 Select the Multiplied by Coefficient mode.

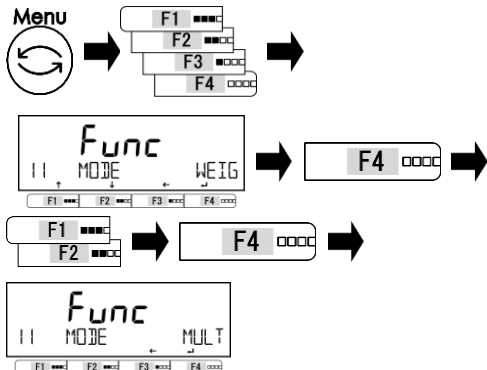

Push [Menu] key, then push [F1-F4] keys to go to <11 MODE>.

Push [F4] key to change the setting value.

Push [F1/F2] key to select.

MULT : Multiplied by Coefficient mode

Push [F4] key to fix.

2 Exit the setting menu.



Push [Menu] key to shift to the Multiplied by Coefficient mode.

3 Select whether or not employ the previous recorded coefficient.



Push [F3/F4] key to select whether or not employ the previous data.

When there is no data record, this step is skipped.

Push [F3/F4] key to select.

NO: Change

YES: Not Change

When <OK> is selected, go to step 6.

4 Set the coefficient.

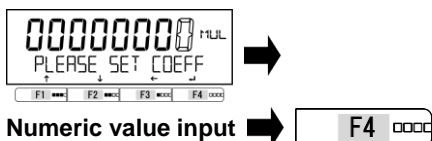

Numeric value input

(Refer to "2-5-3 Numeric value input")

Input the coefficient.

Push [F4] key to fix.

5 Weigh the samples.

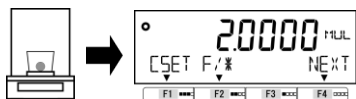

The weight of the sample is multiplied by the coefficient and the result is displayed.

3-4-1 Switching the display at Multiplied by Coefficient

1 Push [F1-F4] keys to switch the display.

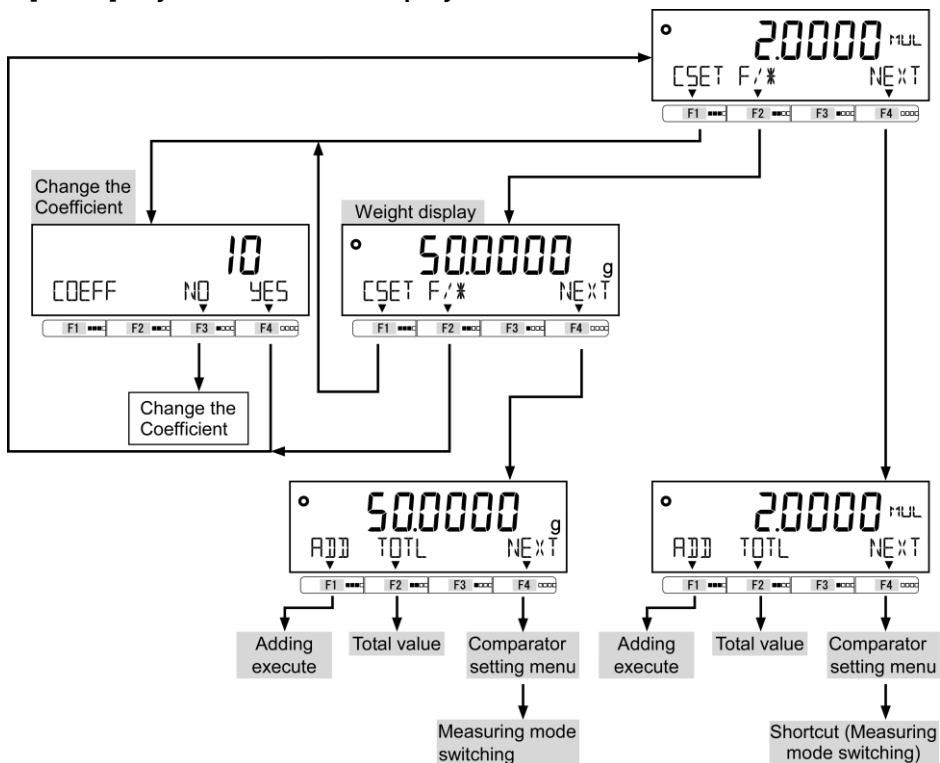

Reference <ADD> and <TOTL> can be used when the <14 ADDITION> is "Valid".

3-5 Specific gravity mode



This mode is not legal for trade.

In the specific gravity mode, the ratio of the density of a substance to the density of water at its densest (4°C) for liquids is calculated.

When measuring the specific gravity of solid, purchase the optional "specific gravity measurement kit" or prepare the equipments — a water tank, hanging string/wire, net/basket for placing the sample, thermometer etc.— in accordance with the samples to be measured.

When purchased with "specific gravity measurement kit" or measuring the specific gravity of liquid, please refer to the option's manual.

3-5-1 Procedure for measuring specific gravity of the solid sample

Procedure to measure the specific gravity:

1. Prepare the equipments or specific gravity measurement kit
2. Input the water temperature or the specific gravity of the reference liquid.
3. Measure the sample weight in the air.
4. Compensate the buoyancy acting on the net/basket.
5. Measure the sample weight in the water/liquid.
6. The specific gravity of the sample is displayed.

1

Select the specific gravity mode.

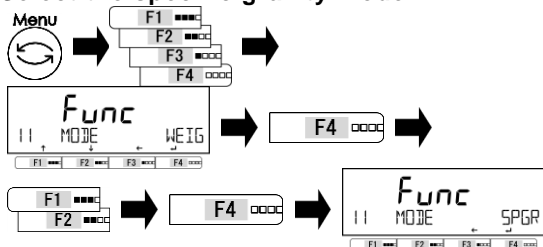

Push [Menu] key, then push [F1-F4] keys to go to <11 MODE>
 Push [F4] key to change the setting value.
 Push [F1/F2] key to select.
 SPGR: specific gravity mode
 Push [F4] key to fix.

2

Exit the setting menu.

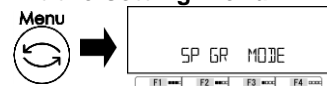

Push [Menu] key to shift to the specific gravity mode.

3

Select the measurement mode.

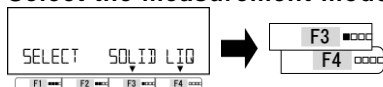

Push [F3/F4] key to select the measurement mode.
 SOLID: Solid specific gravity mode
 LIQ: Liquid specific gravity mode

4

Select the reference liquid.



Push [F3/F4] key to select the reference liquid.
 OTHER: Liquid other than water
 H2O: water

5

Input the specific gravity of the reference liquid or the temperature of the water.

<OTHER>: Liquid other than water

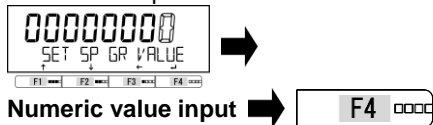

Numeric value input
 (Refer to "2-5-3 Numeric value input")

<H2O>: Water

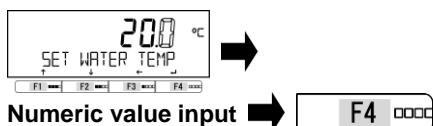

Numeric value input
 (Refer to "2-5-3 Numeric value input")

Enter the specific gravity of the reference liquid and push [F4] key to fix.

Enter the temperature of the water and push [F4] key to fix.

6

Measure the sample weight in the air.

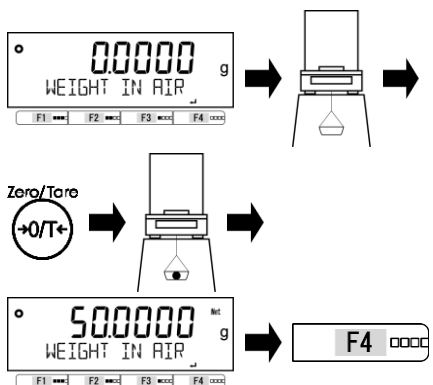

Set the net/basket on the balance and push [Zero/Tare] key.
 Load the on the net/basket to measure the weight of the sample in the air, then push [F4] key to record it.

7 Compensate the buoyancy acting on the net/basket.

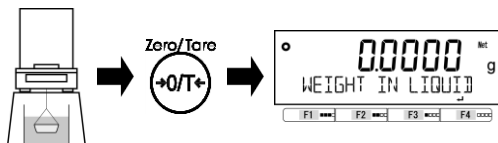

Remove the sample on the net/basket and push [Zero/Tare] key to tare, then sink the net/basket into the water/liquid. Push [Zero/Tare] key to compensate the buoyancy acting on the net/basket.

8 Measure the sample weight in the water/liquid.

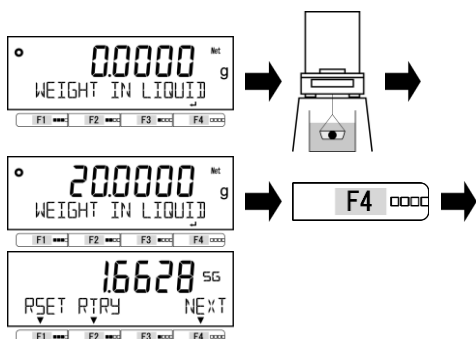

Put the sample on the net/basket in the water/liquid, then push [F4] key to record.

The specific gravity of the sample (for the 4°C water) is automatically calculated and displayed.

3-5-2 Switching the display at “Specific gravity mode”

1 Push [F1-F4] keys to switch the display.

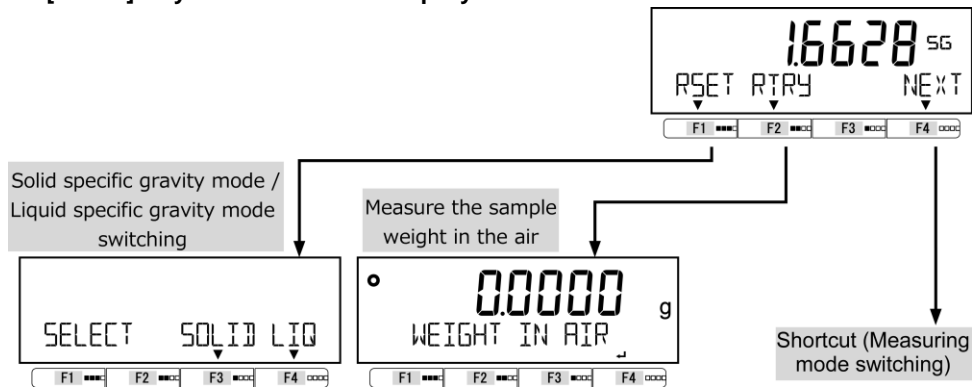

3-6 Unit setting

Various units can be selected. Please also refer to "Appendix 3 Unit conversion table" and "Appendix 4 Weighing capacity and readability by unit"



Only "mg", "g" and "ct" are available for verified balance.

1 Select the unit setting.

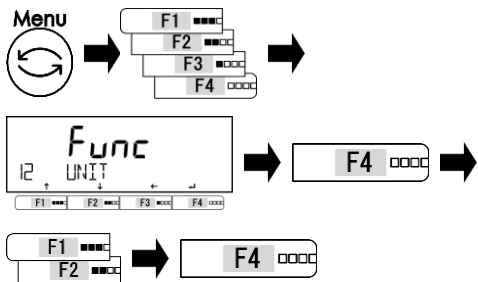

Push [Menu] key, then push [F1-F4] keys to go to <12 UNIT>.

Push [F4] key to change the setting value.

Push [F1/F2] key to select the unit (Refer to Unit Setting Menu List).

Push [F4] key to fix.

Unit Setting Menu List			
mg : milligram	g : gram	ct : carat	LB : pound
OZ : ounce	OZT : troy ounce	GN : grain	DWT : pennyweight
MOM : momme	MSG : mesghal	TLH : Hong Kong tael	TLT : Taiwan tael
TLS : Singapore, Malaysia tael	TOLA : tola	BAT : baht	

2 Exit the setting menu.

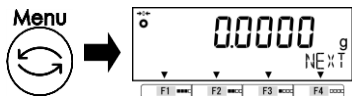

Push [Menu] key to shift to the measuring modes.

3-7 Comparator function

It is possible to preset threshold values (limits) and determine whether or not a measured value is within the range defined by the preset values.



The comparator function can be used in Weighing mode, Percentage mode, Counting mode, and Multiplied by Coefficient mode.

3-7-1 How to perform discrimination

Set the lower and the upper limits. Then, whether the weight of a sample to be weighed is "LOW" (lower than the lower limit), "OK" (appropriate) or "HIGH" (higher than the upper limit), is indicated on the LCD with "16-segment messages".

Discrimination	16-segment messages		
	Single point setting (lower limit)	Single point setting (upper limit)	Two-point setting (upper and lower limits)
Over the upper limit	< OK > Blinking	< HIGH > Blinking	< HIGH > Blinking
Appropriate amount	< OK > Blinking	< OK > Blinking	< OK > Blinking
Below the lower limit	< LOW > Blinking	< OK > Blinking	< LOW > Blinking

The discrimination is performed according to the following criteria:

- Absolute value: The discrimination is performed based on the upper and lower limit values that have been set in advance.
- Relative value: A reference numeric value is set in advance, and the discrimination is performed based on the range defined by the upper and lower limit values that have been set for the reference numeric value.

(For example) Two-point (upper and lower limits) setting, Reference value = 100.0000g, Lower limit value = 90.0000 g, Upper limit value = 120.0000 g

Discrimination method	Reference value	Lower limit value	Upper limit value
	100.0000 g	90.0000 g	120.0000 g
Absolute value		90.0000 g	120.0000 g
Relative value	100.0000 g	-10.0000 g	20.0000 g

3-7-2 Comparator function setting

Reference

For the setting of the reference value and upper and lower limit values, refer to "5 User information setting".

1 Select the comparator function.

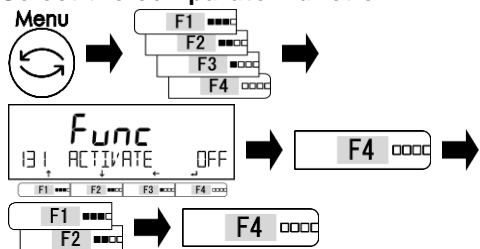

Push [Menu] key, then push [F1-F4] keys to go to <131 ACTIVATE>
Push [F4] key to change the setting value.
Push [F1/F2] key to select.

- OFF: OFF
- H / L: Upper and lower limits valid
- HIGH: Upper limit alone valid
- LOW: Lower limit alone valid

Push [F4] key to fix.

2 Select the discriminant condition.

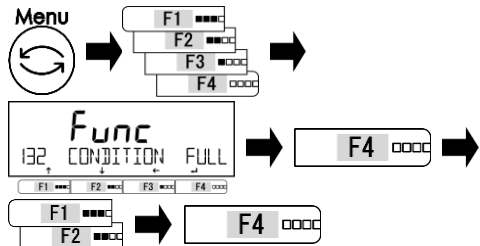

Push [F1-F4] keys to go to <132 CONDITION>
Push [F4] key to change the setting value.
Push [F1/F2] key to select.

- FULL: At all times
 - STBL: Only at stable times
- Push [F4] key to fix.

3 Select the discriminant range.

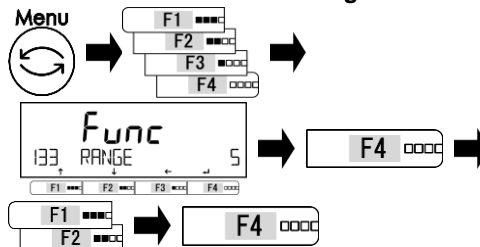

Push [F1-F4] keys to go to <133 RANGE>
Push [F4] key to change the setting value.
Push [F1/F2] key to select.

- 5: +5 (e/d) or more
 - 50: +50 (e/d) or more
 - FULL: Entire area
- Push [F4] key to fix.

4 Select the discriminant method.

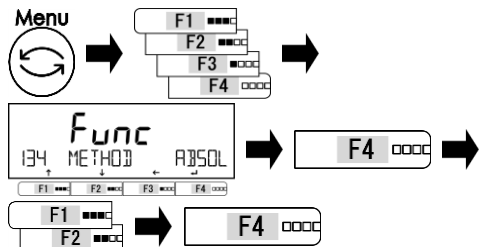

Push [F1-F4] keys to go to <134 METHOD>
Push [F4] key to change the setting value.
Push [F1/F2] key to select.

- ABSOL: Absolution value method
 - RELAT: Relative value method
- Push [F4] key to fix.

3-8 Adding function

Weigh a plurality of samples to be weighed in sequence and indicates its total value.
 The adding function includes two ways of calculating method.

- Method of weighing samples to be weighed while Addition accumulating function. replacing the samples:
- Method of weighing samples to be weighed without Net adding function. replacing the samples:

Reference The adding function can be used in Weighing mode, Percentage mode, Counting mode, and Multiplied by Coefficient mode.

1 Select the adding function.

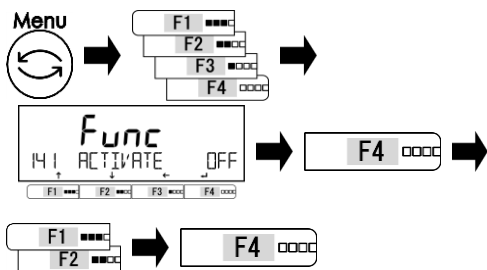

Push [Menu] key, then push [F1-F4] keys to go to <141 ACTIVATE>
 Push [F4] key to change the setting value.
 Push [F1/F2] key to select.
 OFF: Invalid
 ON: Valid
 Push [F4] key to fix.

2 Select the adding operation.

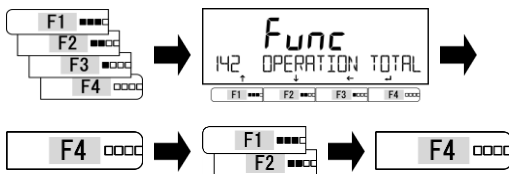

Push [F1-F4] keys to go to <142 OPERATION>
 Push [F4] key to change the setting value.
 Push [F1/F2] key to select.
 TOTAL: Addition accumulated
 NET: Net addition
 Push [F4] key to fix.

3 Select the adding direction.

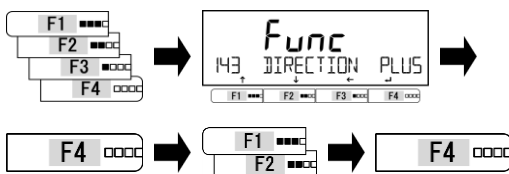

Push [F1-F4] keys to go to <143 DIRECTION>
 Push [F4] key to change the setting value.
 Push [F1/F2] key to select.
 PLUS : Plus side addition
 MINUS : Minus side addition
 Push [F4] key to fix.

4 Set the "Free key".

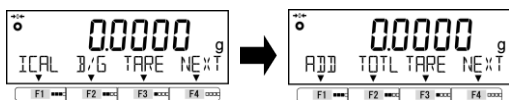

Set the following function to the <<F1-F6>> (Free keys).
 <62* F* KEY ADD> : Adding execute
 <62* F* KEY TOTL> : Total indication
 (Refer to "8 Controlling and adjustment functions" for setting the free keys.)

Reference Step 4 is required only when you are using an adding function on the weighing mode.

3-8-1 Weighing by means of the plus side addition

When <ADD> is assigned to [F1] key and <TOTL> is assigned to [F2] key.

1 Place a first sample to be weighed.

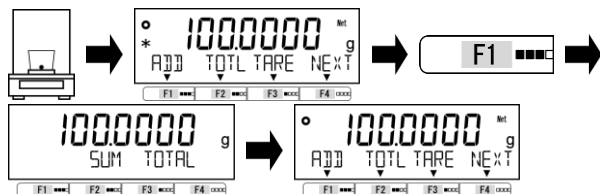

Place a first sample to be weighed.
After <*> appears, push [F1](<<ADD>>) key.

The weighed value is stored and <SUM TOTAL> is indicated for a few seconds. The balance returns to the weight indication.

2 In the case of the addition accumulating Replace a sample to be weighed with a new one.

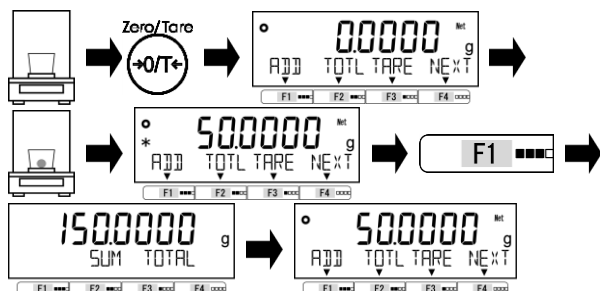

Remove the previous sample and push [Zero] key.
Then place a next sample to be weighed.

After <*> appears, push [F1](<<ADD>>) key.

The weighed value is stored and <SUM TOTAL> is indicated for a few seconds. Repeat this operation to perform addition.

In the case of the net addition Add a sample to be weighed.

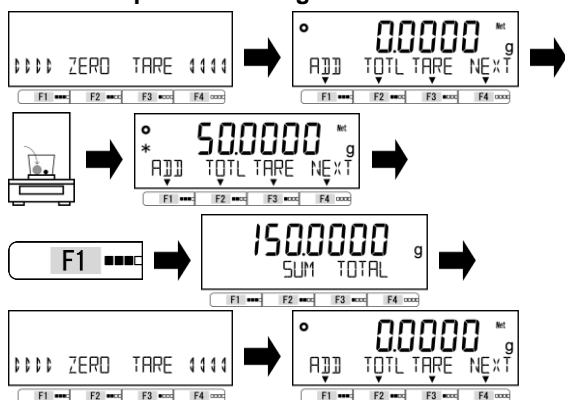

Tare subtraction starts automatically after <SUM TOTAL> indication, then the balance returns to net-zero indication.

Add a sample to be weighed without doing any other operation.
After <*> appears, push [F1](<<ADD>>) key.

The weighed value is stored and <SUM TOTAL> is indicated for a few seconds. Repeat this operation to perform addition.

3 Indicate the total value.

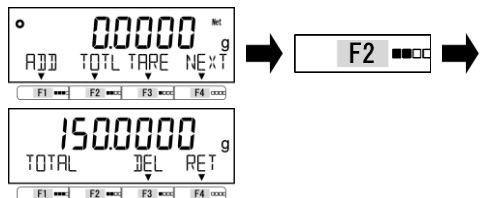

Push [F2](<<TOTL>>) key.
Total value is indicated.

4 Delete the total value.

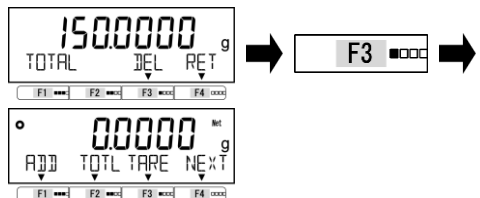

Push [F3]() key.
The total value is deleted.

3-8-2 Weighing by means of the minus side addition

When <ADD> is assigned to [F1] key and <TOTL> is assigned to [F2] key.

1 Place a sample to be weighed.

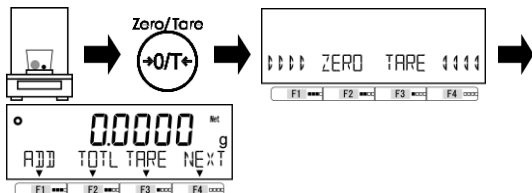

Place a sample to be weighed.
Push [Zero/Tare] key.

**2 In the case of the addition accumulating
Remove the sample to be weighed and perform adding.**

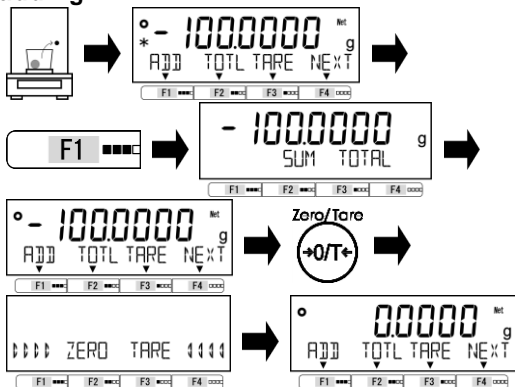

Remove the sample to be weighed.
After <*> appears, push [F1]<<ADD>> key.
The weighed value is stored and <SUM TOTAL> is indicated for a few seconds.
Push [Zero/Tare] key.
Repeat this operation to perform addition.

**3 In the case of the net addition
Remove the sample.**

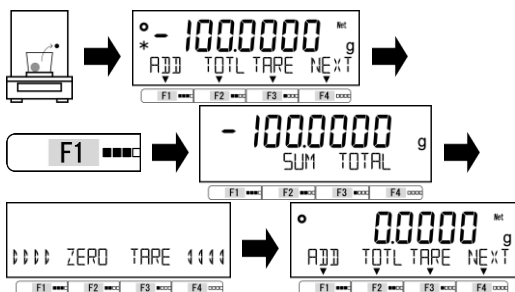

Remove the sample to be weighed.
After <*> appears, push [F1] (<<ADD>>) key.
After indicating <SUM TOTAL> and the accumulated value for a few seconds, the balance returns to the weight indication, followed by the automatic tare.
Repeat this operation to perform addition.

4 Indicate the total value.

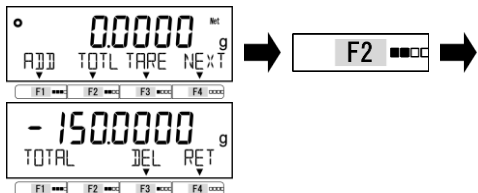

Push [F2]<<TOTL>> key.
Total value is indicated.

5 Delete the total value.

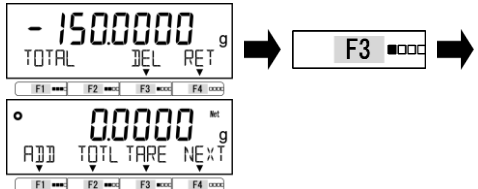

Push [F3]<> key.
The total value is deleted.

3-9 Tare-subtraction reminder function

When the “tare-subtraction reminder” is activated, <PUSH TARE> alert is displayed when the tare (container) is loaded.

Note

When the zero-point-adjustment reminder operates at the same time, the zero-point adjustment reminder has priority.

There are two modes in the tare-subtraction reminder function;

Reference

- (1) 1 (Mode 1): <PUSH TARE> is indicated when the weighing indication is over the zero-point-adjustment range.
- (2) 2 (Mode 2): <PUSH TARE> is indicated when the weighing indication is over the zero-point-adjustment range before tare subtraction, and when the net indication is negative after tare subtraction.

1 Select the “tare-subtraction reminder function”.

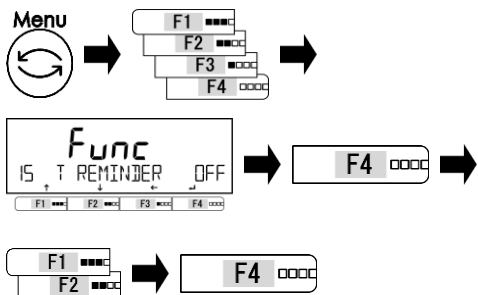

Push [Menu] key, then push [F1-F4] keys to go to <15 T REMINDER>.

Push [F4] key to change the setting menu.

Push [F1/F2] key to select.

- OFF : Invalid
- 1 : Activate the “Mode 1”
- 2 : Activate the “Mode 2”

Push [F4] key.

2 Exit the setting menu and operate with “tare-subtraction reminder”.

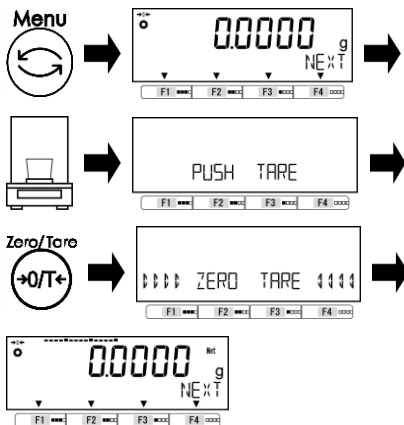

Push [Menu] key to exit the setting menu.

Place a tare (container) on the weighing pan, then <PUSH TARE> alert is displayed.

The alert disappears after [Zero/Tare] key is pushed and tare-subtraction is completed.

Therefore, the indication becomes zero and <Net> indication appears.

3-10 Zero-point-adjustment reminder function

When the “zero-point-adjustment reminder” is activated, <PUSH ZERO> alert is displayed when the load return to within the “zero-point adjustment range” after the load is once over the range.

1 Activate the “zero-point-adjustment reminder”.

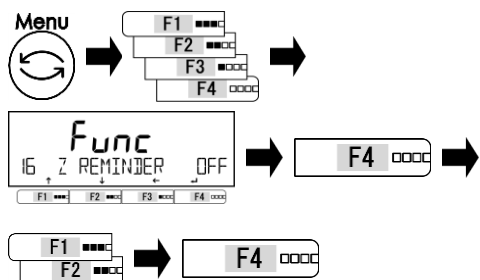

Push [Menu] key, then push [F1-F4] keys to go to <16 Z REMINDER>, and then push [F4] key to change the setting. Push [F1/F2] key to select activate or disable the function.

OFF: Disable
ON: Activate

Push [F4] key to fix.

2 Exit the setting menu and operate with “zero-point adjustment reminder”.

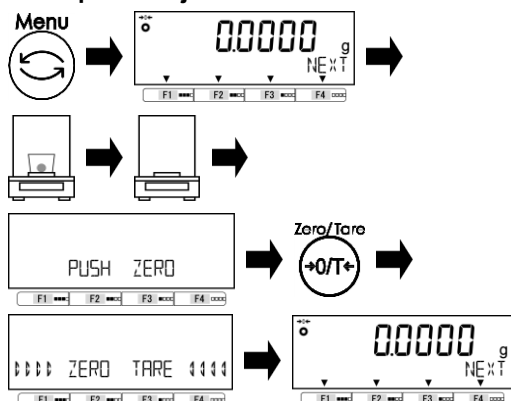

Push [Menu] key to exit the setting menu.

Put the samples on the weighing pan then remove it, then the <PUSH ZERO> alert is displayed.

The alert disappears after [Zero/Tare] key is pushed and zero-point adjustment is completed.

3-11 Stabilization wait setting

Set when to indicate the weighed value after the zero-point adjustment or tare; either after or before the weighed value stabilizes.



For verified balance:

- This setting menu is not available;
- The balance always wait stabilization before indicating weighed value after the zero-point adjustment or tare.

1 Select the stabilization wait setting.

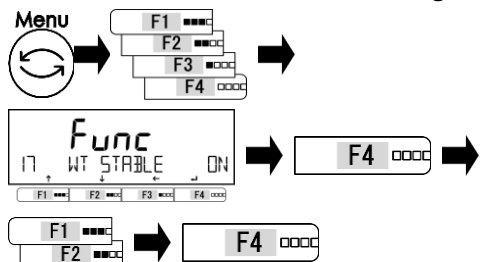

Push [Menu] key, then push [F1-F4] keys to go to <17 WT STABLE>.

Push [F4] key to change the setting value.

Push [F1/F2] key to select.

OFF: Invalid
ON: Valid

Push [F4] key to fix.

2 Exit the setting menu.

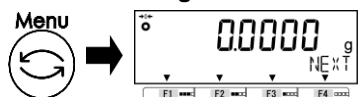

Push [Menu] key to shift to the measuring mode.

3-12 Bar graph indication

Set the indication/non-indication of the bar graph.

1 Select the bar graph indication.

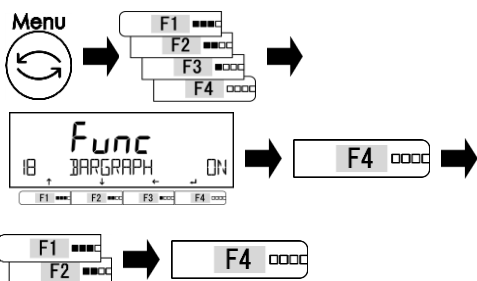

Push [Menu] key, then push [F1-F4] keys to go to <18 BARGRAPH>.

Push [F4] key to change the setting value.

Push [F1/F2] key to select.

OFF: Invalid

ON: valid

Push [F4] key to fix.

2 Exit the setting menu.

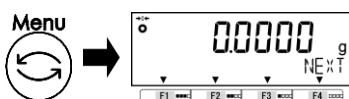

Push [Menu] key to shift to the measuring mode.

3-13 Backlight setting

Setting the backlight control.

1 Select the backlight setting.

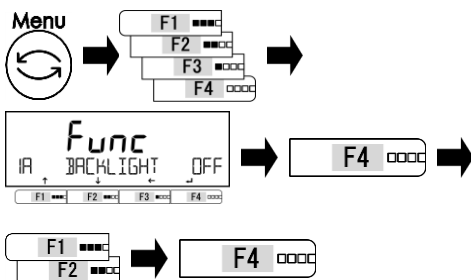

Push [Menu] key, then push [F1-F4] keys to go to <1A BACKLIGHT>.

Push [F4] key to change the setting value.

Push [F1/F2] key to select.

Refer to the "Set List".

Push [F4] key to fix.

Set List		
OFF : Invalid	3MIN : 3 minutes	5MIN : 5 minutes
10MIN : 10 minutes	30MIN : 30 minutes	ON : Always ON

2 Exit the setting menu.

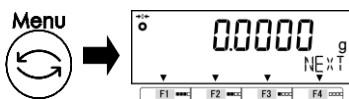

Push [Menu] key to shift to the measuring mode.

Reference

For accurately weighing, please set <1A BACKLIGHT> to continuously "ON" or "OFF".

When the balance is battery powered, it is recommended to set backlight settings to continuously "OFF" to save the power.

3-14 Auto power-off

This function is to automatically turn off the power for the balance.

1 Select the auto power-off.

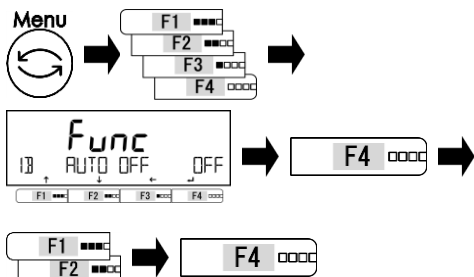

Push [Menu] key, then push [F1-F4] keys to go to <1B AUTO OFF>.

Push [F4] key to change the setting value.

Push [F1/F2] key to select.

Refer to the "Set List".

Push [F4] key to fix.

Set List		
OFF : Invalid	3MIN : 3 minutes	5MIN : 5 minutes
10MIN : 10 minutes	30MIN : 30 minutes	

2 Exit the setting menu.

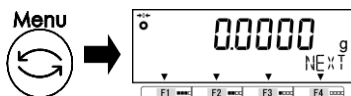

Push [Menu] key to shift to the measuring mode.

The "Backlight setting" and "Auto power-off" function does not work under the following conditions:

Reference

- (1) Setting menu is being displayed.
- (2) A sample is placed on the weighing pan and the display is not stable (When <O> is not displayed.).

3-15 "Simple SCS(Self Counting System) method" setting

"Simple SCS method" is auxiliary function for Counting mode.

First, put a set number of samples in place. Next, put up to two times the set number of additional samples in place. The balance will automatically update the average sample weight. Repeating this step allows accurate counting.

1 Select the simple SCS.

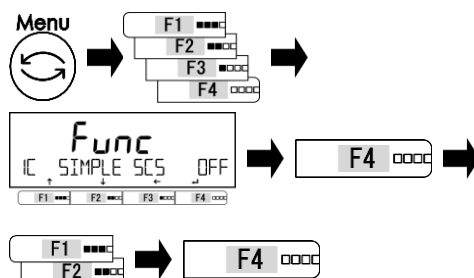

Push [Menu] key, then push [F1-F4] keys to go to <1C SIMPLE SCS>.

Push [F4] key to change the setting value.

Push [F1/F2] key to select.

OFF: Invalid

ON: valid

Push [F4] key to fix.

2 Exit the setting menu.



Push [Menu] key to shift to the measuring mode.

4 Functions related to the performance

Set the balance indication stability and response speed.

4-1 Hierarchy of functions related to the performance



For verified balance, gray shaded items () are not indicated.

★: Initial setting value

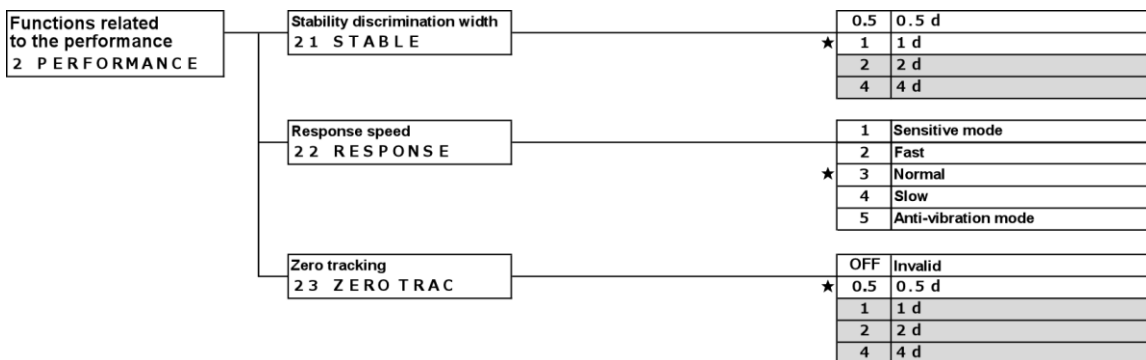

4-2 Stability discrimination width

When the larger numeric value is set in this setting menu, the laxer stability judgement is applied and the balance indicate “Stable mark” <O> in more unstable conditions.



For verified balance, <21 STABLE 2,4> are not available.

1 Select the stability discrimination width.

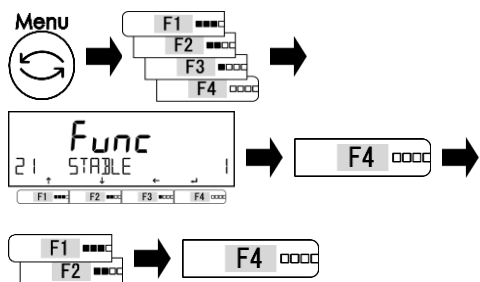

Push [Menu] key, then push [F1-F4] keys to go to <21 STABLE>.

Push [F4] key to change the setting value.

Push [F1/F2] key to select.

0.5: 0.5d

1: 1.0d

2: 2.0d

4: 4.0d

Push [F4] key to fix.

2 Exit the setting menu.

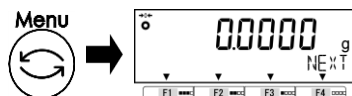

Push [Menu] key to shift to the measuring mode.

4-3 Response speed

The larger numeric value is set in this setting menu, the more stable the balance indication becomes in unstable conditions.

1 Select the response speed.

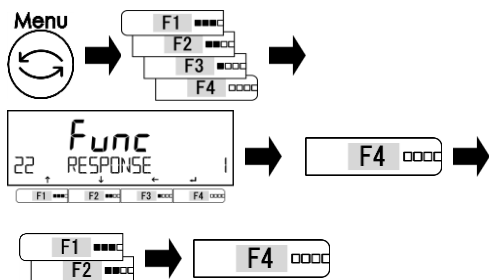

Push [Menu] key, then push [F1-F4] keys to go to <22 RESPONSE>.

Push [F4] key to change the setting value.

Push [F1/F2] key to select.

Refer to Set List.

Push [F4] key to fix.

Set list		
1 : Sensitive mode	2 : Fast	3 : Normal
4 : Slow	5 : Anti-vibration mode	

2 Exit the setting menu.

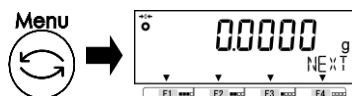

Push [Menu] key to shift to the measuring mode.

4-4 Zero tracking

Setting to the zero tracking function makes it possible to automatically correct the zero-point fluctuation caused by the temperature fluctuation, etc. when "0" is indicated, through which the "0" indication is maintained.



For verified balance, <23 ZERO TRAC 1, 2 and 4> are not available.

1 Select the zero tracking.

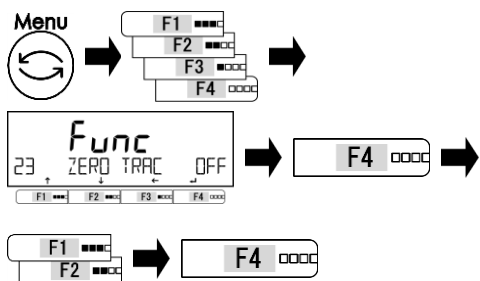

Push [Menu] key, then push [F1-F4] keys to go to <23 ZERO TRAC>.

Push [F4] key to change the setting value.

Push [F1/F2] key to select.

Refer to Set List.

Push [F4] key to fix.

Set list		
OFF : Invalid	0.5 : 0.5d	1 : 1d
2 : 2d	4 : 4d	

2 Exit the setting menu.

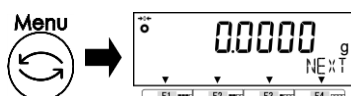

Push [Menu] key to shift to the measuring mode.

5 User information setting

Describes about setting items related to the comparator function and preset tare weight.

5-1 Hierarchy of user information setting



For verified balance, gray shaded items () are not indicated.

★: Initial setting value

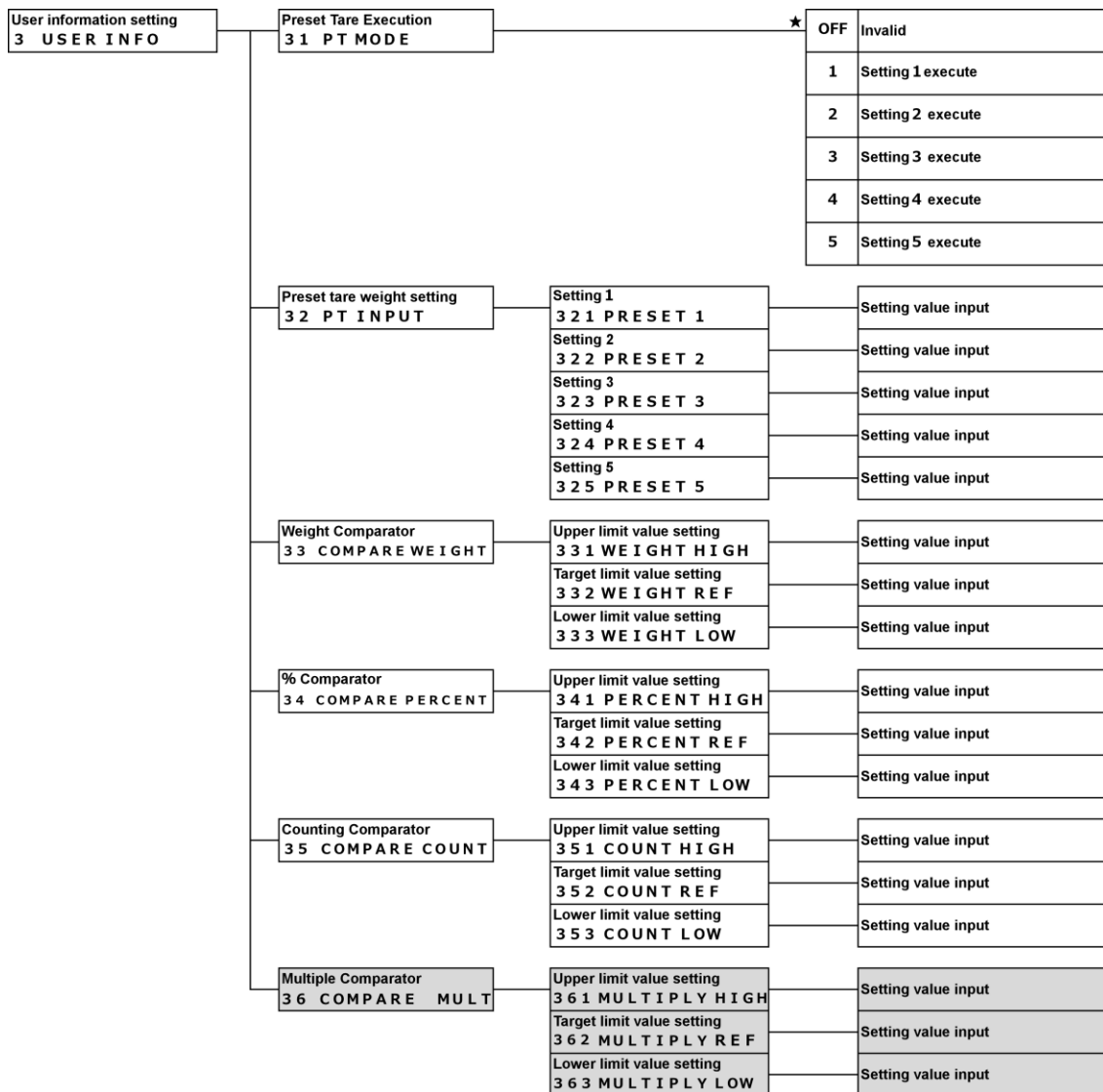

5-2 Preset tare

When using a tare whose tare weight is already known, the tare subtraction can be performed in advance by inputting its tare weight (preset tare weight). Five preset tare weight values can be registered.

5-2-1 Preset tare setting

1 Select the Preset tare setting.

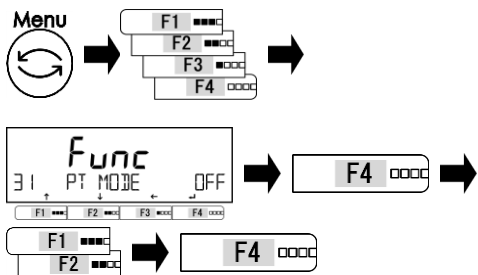

Push [Menu] key, then push [F1-F4] keys to go to <31 PT MODE>.

Push [F4] key to change the setting value.

Push [F1/F2] key to select.

Refer to Set List.

Push [F4] key to fix.

Set list		
OFF : Invalid	1 : Setting 1 execute	2 : Setting 2 execute
3 : Setting 3 execute	4 : Setting 4 execute	5 : Setting 5 execute

2 Exit the setting menu.



Push [Menu] key to shift to the measuring mode.

Preset tared value is displayed with <Net Pt> indication when preset tare value is available.

5-2-2 Inputting of a preset tare weight value

There are two ways of inputting a preset tare weight value. described below:

- Actual value setting method: Weighing a sample with a balance and then making it a setting value.
- Numeric value setting method: Inputting a setting value directly via key operation.

1 Select the preset tare weight setting.

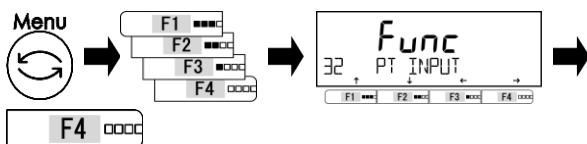

Push [Menu] key, then push [F1-F4] keys to go to <32 PT INPUT>.

Push [F4] key.

2 Select the "Actual value setting method" or "Numeric value setting method".

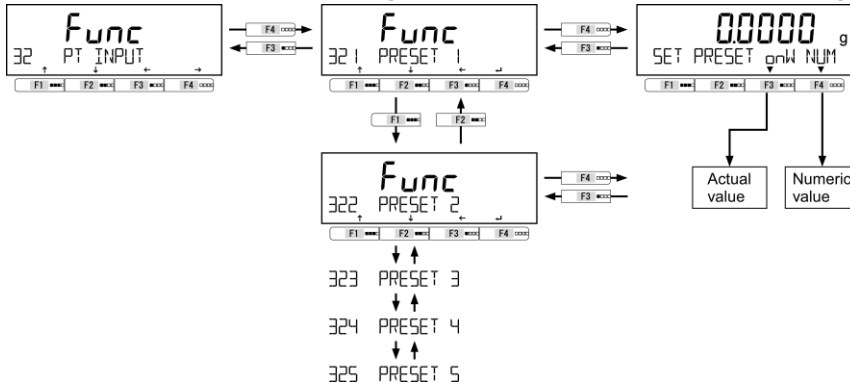

5-2-2 (1) Actual value setting method

1 Set a preset tare weight value.

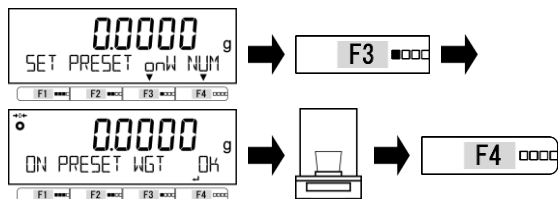

Push [F3] key to select.

onW : Actual value

Place a sample to be weighed that is equivalent to the tare weight value.

Push [F4] key to fix.

The preset tare weight value is stored.

2 Exit the setting menu.

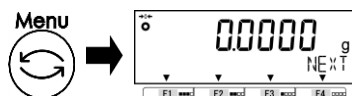

Push [Menu] key to shift to the measuring mode.

5-2-2 (2) Numeric value setting method

1 Set a preset tare weight value.

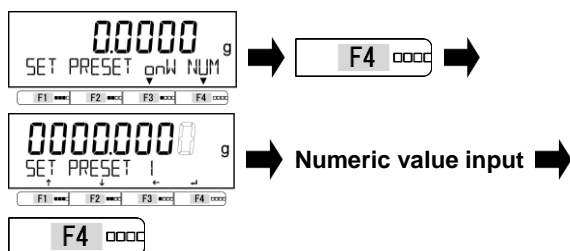

Push [F4] key to select.

NUM : Numeric value

Input the preset tare value.

Push [F4] key to fix.

The preset tare weight value is stored.

(Refer to “2-5-3 Numeric value input”)

2 Exit the setting menu.

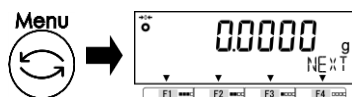

Push [Menu] key to shift to the measuring mode.

5-2-2 (3) Exiting the preset tare mode

1 To exit the preset tare mode.

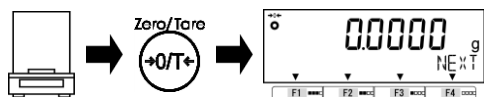

Make sure that nothing is placed on the weighing pan.

Push [Zero/Tare] key.

Then <Net Pt> disappears and the preset tare mode has exited.

5-3 Setting of the discrimination value of the comparator function

There are two ways of inputting a reference value and upper and lower limit values as described below:

- Actual value setting method: Weighing a sample with a balance and then making it a setting value.
- Numeric value setting method: Inputting a setting value directly via key operation.

The discrimination is performed according to the following criteria:

- Absolute value: The discrimination is performed based on the upper and lower limit values that have been set in advance.
- Relative value: A reference numeric value is set in advance, and the discrimination is performed based on the range defined by the upper and lower limit values that have been set for the reference numeric value.

(For example) Two-point (upper and lower limits) setting, Reference value = 100.0000g, Lower limit value = 90.0000 g, Upper limit value = 120.0000 g

Discrimination method	Reference value	Lower limit value	Upper limit value
		100.0000 g	90.0000 g
Absolute value		90.0000 g	120.0000 g
Relative value	100.0000 g	-10.0000 g	20.0000 g

1 Select the “Actual value setting method” or “Numeric value setting method”.

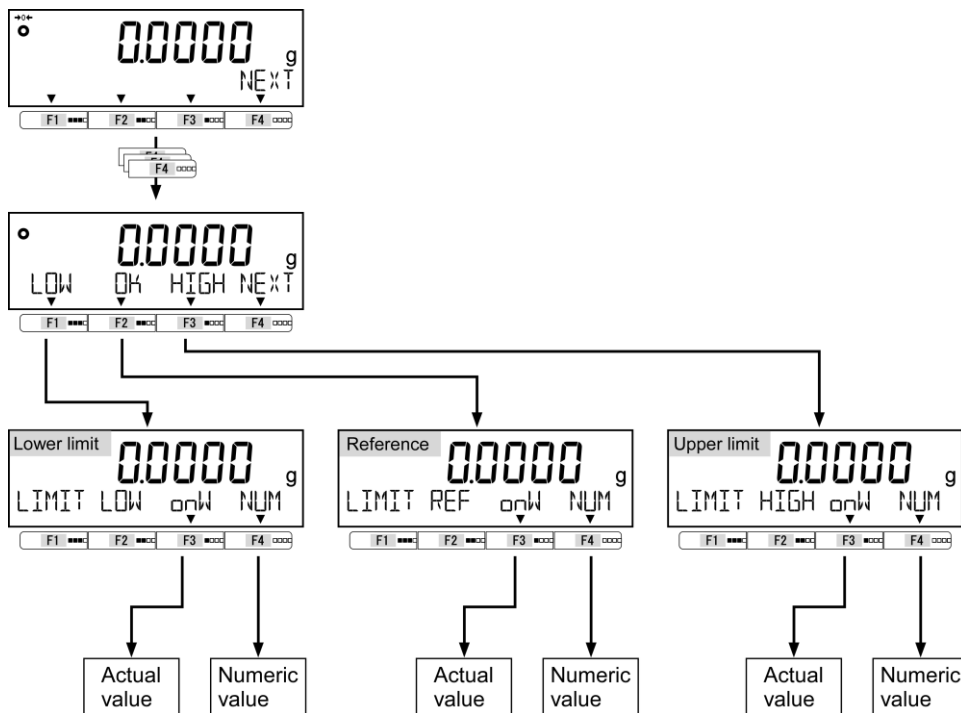

(1) Reference value, Lower limit value and Upper limit value can be set also via Setting menu below.

Reference

- Comparator setting for Weighing mode: 33 COMPARE WEIGHT
- Comparator setting for Percentage mode: 34 COMPARE PERCENT
- Comparator setting for Counting mode: 35 COMPARE COUNT
- Comparator setting for Multiplied by Coefficient mode: 36 COMPARE MULT

(2) Comparator function is available in Weighing mode, Percentage mode, Counting mode and Multiplied by Coefficient mode.

5-3-1 Actual value setting method

1 Set a lower limit value.

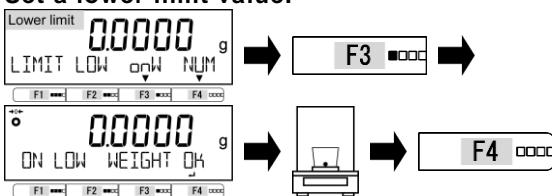

Push [F3] key to select.
onW : Actual value
Place a sample to be weighed that is equivalent to the lower limit value.
Push [F4] key to fix.
The lower limit value is recorded.

2 Set a reference value.
(In the case of the relative value discrimination)

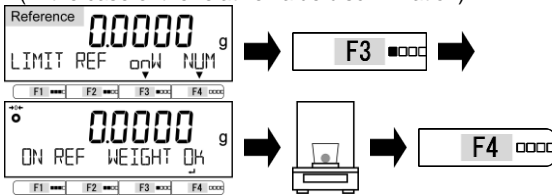

Push [F3] key to select.
onW : Actual value
Place a sample to be weighed that is equivalent to the reference limit value.
Push [F4] key to fix.
The reference value is recorded.

3 Set an upper limit value.

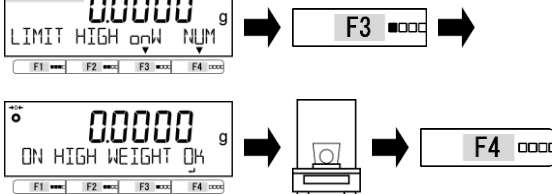

Push [F3] key to select.
onW : Actual value
Place a sample to be weighed that is equivalent to the upper limit value.
Push [F4] key to fix.
The upper limit value is recorded.

5-3-2 Numeric value setting method

1 Set a lower limit value.

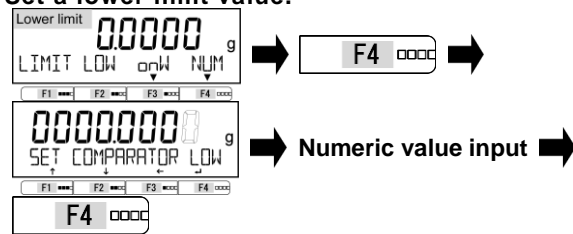

Push [F4] key to select.
NUM : Numeric value
Input the lower limit value.
Push [F4] key to fix.
The lower limit value is saved.

(Refer to "2-5-3 Numeric value input")

2 Set a reference value.
(In the case of the relative value discrimination)

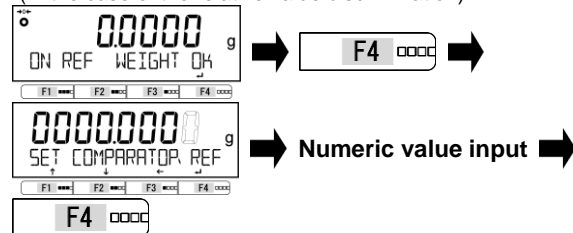

Push [F4] key to select.
NUM : Numeric value
Input the reference value.
Push [F4] key to fix.
The reference value is saved.

(Refer to "2-5-3 Numeric value input")

3 Set an upper limit value.

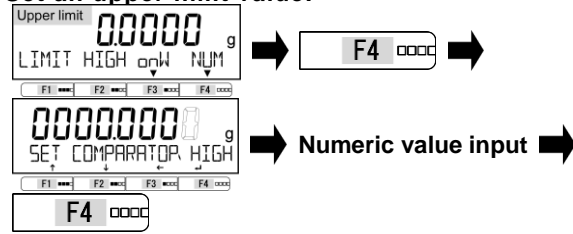

Push [F4] key to select.
NUM : Numeric value
Input the upper limit value.
Push [F4] key to fix.
The upper limit value is saved.

(Refer to "2-5-3 Numeric value input")

6 External input/output functions

This function is used for communication through the external peripheral devices. There are RS-232C (D-SUB 9P and DIN8P) interface as standard equipment.

6-1 Hierarchy of the external input / output functions

Legal
Metrology

For verified balance:

- Gray shaded items () are not indicated;
- <41A STATUS> is not indicated and fixed to be <ON>;
- <412 FORMAT> is not indicated and fixed to be <CBM>.

★: Initial setting value

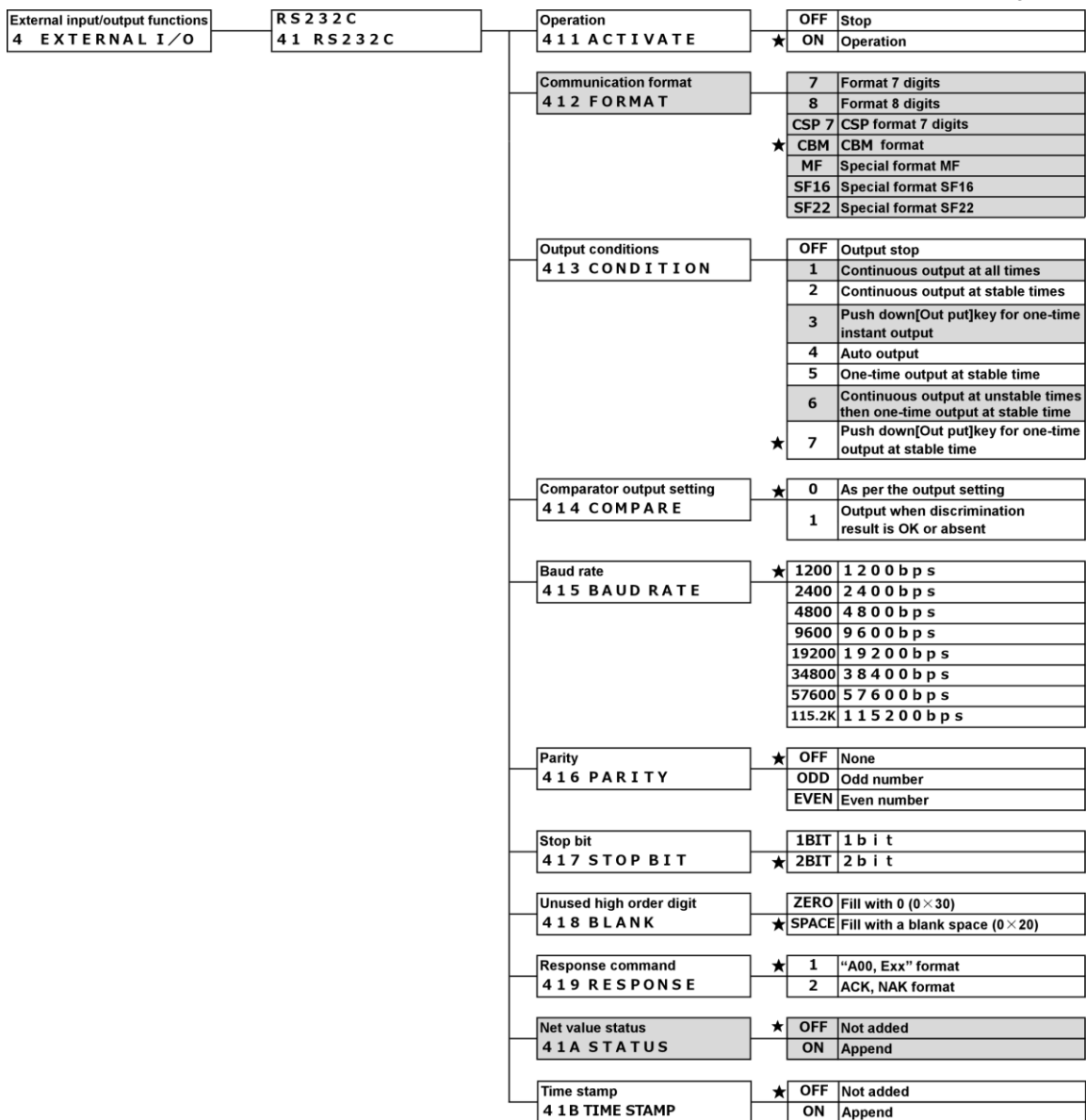

6-2 Connector terminal numbers and their functions

6-2-1 D-SUB9P Connector

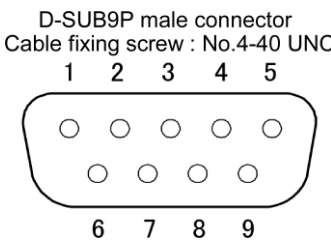
 <p>D-SUB9P male connector Cable fixing screw : No.4-40 UNC</p>	Terminal No.	Signal name	Input/output	Function
	1	–	–	–
2	RXD	Input	Receiving data	
3	TXD	Output	Transmitting data	
4	DTR	Output	HIGH (When the balance is powered ON)	
5	GND	–	Signal grounding	
6	–	–	–	
7	–	–	–	
8	–	–	–	
9	–	–	–	

Note

Use shielded RS232 crossover cable up to 15 m length.

Use the following examples as a guide to connect the balance to external devices using the cable.
- Sample connection with a PC with D-SUB9P connector.

Reference

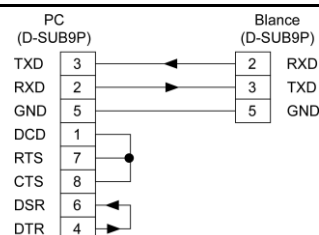

6-2-2 DIN8P Connector

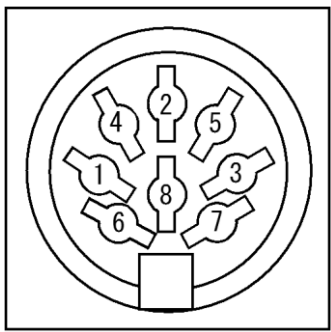
	Terminal No.	Signal name	Input/output	Function
	1	EXT. TARE	Input	Tare subtraction / Zero-point adjustment from external device
2	–	–	–	
3	–	–	–	
4	TXD	Output	Transmitting data	
5	GND	–	Signal grounding	
6	–	–	–	
7	–	–	–	
8	–	–	–	

Note

Use shielded cable up to 15 m length.

Reference

DIN8P Connector can execute tare subtraction or zero-point adjustment from an external device by connecting a contact or a transistor switch between the pin 1 (EXT.TARE) and pin 5 (GND).
When doing so, allow at least 400 ms for connection (ON) time (Maximum voltage: 15 V when the balance is turned OFF, sink current: 20 mA when it is turned ON).

6-3 Communication format

6-3-1 Basic communication specification

Items		Description
Transmission system		Serial transmission, Start-stop synchronization - DSUB9P: bidirectional - DIN8P: unidirectional from the balance to peripherals
Signal level		Equivalent to EIA RS-232C. HIGH level (data logic 0) +5 to +15 V Low level (data logic 1) -5 to -15 V
Baud rate		1200/2400/4800/9600/ 19200/38400/57600/115200bps
Transmission code	Start bit	1 bit
Composition	Parity bit	None/Odd number/Even number
	Data bit	8 bit
	Stop bit	1 bit/2 bit

6-3-2 Basic data output format / CSP format



These formats are not available for verified balance.

1. Data composition

- Measurement result (except specific gravity):

- 7-digit numeric format, CSP 7-digit format

Consists of 16 characters, including terminators (CR=0x0D/LF=0x0A).

1	2	3	4	5	6	7	8	9	10	11	12	13	14	15	16
P1	D1	D2	D3	D4	D5	D6	D7	D8	D9	U1	U2	S1	S2	CR	LF

- 8-digit numeric format

Consists of 17 characters, including terminators (CR=0x0D/LF=0x0A).

1	2	3	4	5	6	7	8	9	10	11	12	13	14	15	16	17
P1	D1	D2	D3	D4	D5	D6	D7	D8	D9	D10	U1	U2	S1	S2	CR	LF

- Others (Date, Time, Specific Gravity etc.):

- 7-digit numeric format, 8-digit numeric format

The message "M1 M2 ... Mn" is suffixed with terminators (CR=0x0D/LF=0x0A).

1	2	...	n	n+1	n+2
M1	M2	...	Mn	CR	LF

- CSP 7-digit format

The message "M1 M2 ... Mn" is:

prefixed with device control code (DC2=0x12); and

suffixed with terminators (CR=0x0D/LF=0x0A) and device control code (DC4=0x14).

1	2	3	...	n+1	n+2	n+3	n+4
DC2	M1	M2	...	Mn	CR	LF	DC4

2. Meaning of the data

Symbol	Code	Description
[P1] (one character) Indicates the polarity of data.		
+	0x2B	Zero or positive data
-	0x2D	Negative data
[D1 to D9/D10] (nine or ten characters) Stores numeric data.		
0 – 9	0x30 – 0x39	0 to 9 (numeric) 0 is also used for zero padding.
.	0x2E	- Decimal point (floating)
(SP)	0x20	- A space at the top of a numeric value - Output to the least significant digit in the absence of a decimal point - Unused high-order digit
/	0x2F	Delimiter to be inserted to the left of the auxiliary-scale-interval place
[U1, U2] (two characters) Indicates the unit used to show numeric data.		
M	G	0x4D 0x47 mg (milligram)
(SP)	G	0x20 0x47 g (gram)
C	T	0x43 0x54 ct (carat)
M	O	0x4D 0x4F mom (momme)
O	Z	0x4F 0x5A oz (ounce)
L	B	0x4C 0x42 lb (pound)
O	T	0x4F 0x54 ozt (troy ounce)
D	W	0x44 0x57 dwt (pennyweight)
G	R	0x47 0x52 GN (grain)
T	L	0x54 0x4C tH (Hong Kong tael)
T	L	0x54 0x4C tS (Singapore, Malaysia tael)
T	L	0x54 0x4C tT (Taiwan tael)
t	o	0x74 0x6F to (tola)
M	S	0x4D 0x53 MSG (mesghal)
B	A	0x42 0x41 BA (baht)
P	C	0x50 0x43 PCS (parts counting)
(SP)	%	0x20 0x25 % (percentage weighing)
(SP)	#	0x20 0x23 # (Multiplied by Coefficient)
[S1] (one character) Indicates the judgment result when the limit function is used.		
L	0x4C	Shortage (LOW)
G	0x47	Proper (OK)
H	0x48	Over (HIGH)
(SP)	0x20	No judgment result or data type specified
e	0x65	Net weight
f	0x66	Tare weight
P	0x50	Preset tare weight
T	0x54	Total value (Accumulated value)
U	0x55	Unit weight
d	0x64	Gross
[S2] (one character) Indicates the status.		
S	0x53	Data stable
U	0x55	Date unstable
E	0x45	Data error (Indicates that data other than S2 is invalid and should be ignored.)
(SP)	0x20	No status specified

6-3-3 CBM data output format

1. Data composition

- Measurement result (except specific gravity):

Composed of 26 characters including a terminator (CR=0x0D/LF=0x0A)

1	2	3	4	5	6	7	8	9	10	11	12	13	(SP): space
S1	C1	(SP)	T1	T2	T3	T4	T5	T6	D1	D2	D3	D4	
14	15	16	17	18	19	20	21	22	23	24	25	26	
D5	D6	D7	D8	D9	D10	D11	D12	U1	U2	(SP)	CR	LF	

- Error message:

Composed of 26 characters including a terminator (CR=0x0D/LF=0x0A)

1	2	3	4	5	6	7	8	9	10	11	12	13	(SP): space
*	*	(SP)	E	R	R	O	R	(SP)	*	*	*	*	
14	15	16	17	18	19	20	21	22	23	24	25	26	
*	*	*	*	*	*	*	*	*	*	(SP)	CR	LF	

- Others (Date, Time, Specific Gravity etc.):

The message "M1 M2 ... Mn" is suffixed with terminators (CR=0x0D/LF=0x0A).

1	2	...	n	n+1	n+2
M1	M2	...	Mn	CR	LF

2. Meaning of the data

Symbol	Code	Description
[S1] (1 character) Represents the status.		
(SP)	0x20	Data stable
*	0x2A	Data unstable
[C1] (1 character) Represents the result of comparator function.		
(SP)	0x20	Comparator result: Proper(OK) or No result Over(HIGH) Shortage(LOW)
H	0x48	
L	0x4C	
[T1-T6] (6 characters) Represents the type of the data.		
(SP) (SP) (SP) (SP) (SP) (SP)	0x20 0x20 0x20 0x20 0x20 0x20	Net weight (<41A STATUS>: <OFF>)
N (SP) (SP) (SP) (SP) (SP) (SP)	0x4E 0x20 0x20 0x20 0x20 0x20	Net weight (<41A STATUS>: <ON>)
P T (SP) (SP) (SP) (SP) (SP) (SP)	0x50 0x54 0x20 0x20 0x20 0x20	Preset tare weight
T (SP) (SP) (SP) (SP) (SP) (SP)	0x54 0x20 0x20 0x20 0x20 0x20	Tare weight
T O T A L (SP) (SP) (SP) (SP) (SP) (SP)	0x54 0x4F 0x54 0x41 0x4C 0x20	Total value (Accumulated value)
G (SP) (SP) (SP) (SP) (SP) (SP)	0x47 0x20 0x20 0x20 0x20 0x20	Gross weight
U N I T (SP) (SP) (SP) (SP) (SP) (SP)	0x55 0x4E 0x49 0x54 0x20 0x20	Unit weight
[D1-D12] (12 characters) Numeric value data is stored.		
+	0x2B	Zero or positive data
-	0x2D	Negative data
0-9	0x30 - 0x39	0 to 9 (numeric) 0 is also used for zero padding.
.	0x2E	Decimal point (floating decimal point)
[0x5B	The number surrounded by '[' and ']' means auxiliary indication
]	0x5D	
(SP)	0x20	- Spaces fill the top of the data. - Output to the least significant digit in the absence of a decimal point - Unused high-order digit

Symbol		Code		Description
[U1, U2] (2 characters) Represents the unit of numeric value data.				
m	g	0x6D	0x67	milligram
(SP)	g	0x20	0x67	gram
c	t	0x63	0x74	carat
m	o	0x6D	0x6F	momme
o	z	0x6F	0x7A	ounce
l	b	0x6C	0x62	pound
O	T	0x4F	0x54	troy ounce
d	w	0x64	0x77	pennyweight
G	R	0x47	0x52	grain
t	l	0x74	0x6C	Hong Kong tael
t	l	0x74	0x6C	Singapore, Malaysia tael
t	l	0x74	0x6C	Taiwan tael
t	o	0x74	0x6f	tola
M	S	0x4D	0x53	mesghal
B	A	0x42	0x41	baht
P	C	0x50	0x43	parts counting
(SP)	%	0x20	0x25	% (percentage weighing)
(SP)	#	0x20	0x23	# (Multiplied by Coefficient)

6-3-4 Special format MF



This format is not available for verified balance.



- (1) Unused high-order digits are filled with space (0x20) regardless of the setting of <418 BLANK>.
- (2) Net value status is not appended regardless of the setting of <41A STATUS>.

1. Data composition

- Measurement result (except specific gravity):

Composed of 18-21 characters including a terminator (CR=0x0D/LF=0x0A)

1	2	3	4	5	6	7	8	9	10	11	
S1	S2	S3	S4	(SP)	D1	D2	D3	D4	D5	D6	(SP): space
12	13	14	15	16	17	18	19	20	21		
D7	D8	D9	D10	(SP)	U1	U2	U3	CR	LF		

- Error messages:

Composed of 5 characters including a terminator (CR=0x0D/LF=0x0A)

1	2	3	4	5	(SP) : space
S1	(SP)	E1	CR	LF	

- Others (Date, Time, Specific Gravity etc.):

The message "M1 M2 ... Mn" is:

prefixed with device control code (DC2=0x12); and

suffixed with terminators (CR=0x0D/LF=0x0A) and device control code (DC4=0x14).

1	2	...	n+1	n+2	n+3	n+4
(DC2)	M1	...	Mn	CR	LF	(DC4)

2. Meaning of the data (Measurement result)

Symbol	Code	Description
[S1-S4] (3-4 characters) Represents the status or type of the data.		
S (SP) S	0x53 0x20 0x53	Data stable
S (SP) D	0x53 0x20 0x44	Data unstable
T (SP) A	0x54 0x20 0x41	Tare weight
T A (SP) A	0x54 0x41 0x20 0x41	Preset tare weight
[D1-D10] (10 characters right-justified) Numeric value data is stored.		
-	0x2D	Negative data
0 - 9	0x30 - 0x39	0 to 9 (numeric)
.	0x2E	Decimal point (floating decimal point)
(SP)	0x20	Spaces fill the top of the data. Unused high-order digit
[0x5B	The number surrounded by '[' and ']'
]	0x5D	means auxiliary indication
[U1-U3] (1-3 characters) Represents the unit of numeric value data.		
m g	0x6D 0x67	milligram
g	0x67	gram
c t	0x63 0x74	carat
m o m	0x6D 0x6F 0x6D	momme
P C S	0x50 0x43 0x53	parts counting
%	0x25	% (percentage weighing)
(SP)	0x20	No unit (Multiplied by Coefficient)

3. Meaning of the data (Error messages)

Symbol	Code	Description
[S1] (1 character)		
S	0x53	Fixed to "S"
[E1] (1 character) Represents the type of error		
+	0x2B	OVER ERROR: In excess of the maximum capacity or maximum number of displayable digits.

6-3-5 Special format SF16/SF22



These formats are not available for verified balance.

Reference

- (1) Unused high-order digits are filled with space (0x20) regardless of the setting of <418 BLANK>.
- (2) Net value status is not appended regardless of the setting of <41A STATUS>.

1. Data composition

- Measurement result (except specific gravity):

- Special format SF16

Consists of 16 characters, including terminators (CR=0x0D/LF=0x0A).

When auxiliary scale interval is available:

1	2	3	4	5	6	7	8
P1	D1	D2	D3	D4	D5	D6	D7
9	10	11	12	13	14	15	16
D8	D9	D10	U1	U2	U3	CR	LF

When auxiliary scale interval is not available:

1	2	3	4	5	6	7	8
P1	(SP)	D1	D2	D3	D4	D5	D6
9	10	11	12	13	14	15	16
D7	D8	(SP)	U1	U2	U3	CR	LF

(SP): Space

- Special format SF22

Consists of 22 characters, including terminators (CR=0x0D/LF=0x0A).

When auxiliary scale interval is available:

1	2	3	4	5	6	7	8	9	10	11
T1	T2	T3	T4	T5	T6	P1	D1	D2	D3	D4
12	13	14	15	16	17	18	19	20	21	22
D5	D6	D7	D8	D9	D10	U1	U2	U3	CR	LF

When auxiliary scale interval is not available:

1	2	3	4	5	6	7	8	9	10	11
T1	T2	T3	T4	T5	T6	P1	(SP)	D1	D2	D3
12	13	14	15	16	17	18	19	20	21	22
D4	D5	D6	D7	D8	(SP)	U1	U2	U3	CR	LF

(SP): Space

- Error messages:

- Special format SF16

Consists of 16 characters including a terminator (CR=0x0D/LF=0x0A)

1	2	3	4	5	6	7	8
(SP)	(SP)	(SP)	(SP)	(SP)	E1	E2	E3
9	10	11	12	13	14	15	16
E4	(SP)	(SP)	(SP)	(SP)	(SP)	CR	LF

(SP): Space

- Special format SF22

Consists of 22 characters including a terminator (CR=0x0D/LF=0x0A)

1	2	3	4	5	6	7	8	9	10	11
T1	T2	T3	T4	T5	T6	(SP)	(SP)	(SP)	(SP)	(SP)
12	13	14	15	16	17	18	19	20	21	22
E1	E2	E3	E4	(SP)	(SP)	(SP)	(SP)	(SP)	CR	LF

(SP): Space

- Others (Date, Time, Specific Gravity etc.):

- Special format SF16, Special format SF22

The message "M1 M2 ... Mn" is:

prefixed with device control code (DC2=0x12); and

suffixes with terminators (CR=0x0D/LF=0x0A) and device control code (DC4=0x14).

1	2	...	n+1	n+2	n+3	n+4
(DC2)	M1	...	Mn	CR	LF	(DC4)

2. Meaning of the data (Measurement result)

Symbol						Code						Description
[T1-T6] (6 characters) Represents the type of the data.												
N	(SP)	(SP)	(SP)	(SP)	(SP)	0x4E	0x20	0x20	0x20	0x20	0x20	Net weight
G	#	(SP)	(SP)	(SP)	(SP)	0x47	0x23	0x20	0x20	0x20	0x20	Gross weight
T	(SP)	(SP)	(SP)	(SP)	(SP)	0x54	0x20	0x20	0x20	0x20	0x20	Tare weight
T	1	(SP)	(SP)	(SP)	(SP)	0x54	0x31	0x20	0x20	0x20	0x20	Preset tare weight
Q	n	t	(SP)	(SP)	(SP)	0x51	0x6E	0x74	0x20	0x20	0x20	Parts counting
w	R	e	f	(SP)	(SP)	0x77	0x52	0x65	0x66	0x20	0x20	Unit weight
P	r	c	(SP)	(SP)	(SP)	0x50	0x72	0x63	0x20	0x20	0x20	Percentage weighing
S	u	m	(SP)	(SP)	(SP)	0x53	0x75	0x6D	0x20	0x20	0x20	Total value (Accumulated value)
R	e	s	(SP)	(SP)	(SP)	0x52	0x65	0x73	0x20	0x20	0x20	Multiplied by Coefficient
H	o	l	d	(SP)	(SP)	0x48	0x6F	0x6C	0x64	0x20	0x20	Holded value
[P1] (1 character) Indicate the polarity of the data												
+						0x2B						Zero or positive data
-						0x2D						Negative data
[D1-D8] (8 characters) Numeric value data is stored.												
0 - 9						0x30 - 0x39						0 to 9 (numeric)
.						0x2E						Decimal point (floating decimal point)
(SP)						0x20						Spaces fill the top of the data. Unused high-order digit
[0x5B						The number surrounded by '[' and ']' means auxiliary indication
]						0x5D						
[U1-U3] (3 characters) Represents the unit of numeric value data or the status of the data.												
(SP)	(SP)	(SP)	(SP)	(SP)	(SP)	0x20	0x20	0x20	0x20	0x20	Data unstable	
m	g	(SP)	(SP)	(SP)	(SP)	0x6D	0x67	0x20	0x20	0x20	milligram	
g	(SP)	(SP)	(SP)	(SP)	(SP)	0x67	0x20	0x20	0x20	0x20	gram	
c	t	(SP)	(SP)	(SP)	(SP)	0x63	0x74	0x20	0x20	0x20	carat	
m	o	m	(SP)	(SP)	(SP)	0x6D	0x6F	0x6D	0x6D	0x6D	momme	
p	c	s	(SP)	(SP)	(SP)	0x70	0x63	0x73	0x73	0x73	parts counting	
%	(SP)	(SP)	(SP)	(SP)	(SP)	0x25	0x20	0x20	0x20	0x20	% (percentage weighing)	
o	(SP)	(SP)	(SP)	(SP)	(SP)	0x6F	0x20	0x20	0x20	0x20	Multiplied by Coefficient	

3. Meaning of the data (Error messages)

Symbol						Code						Description
[T1-T6] (6 characters) Represents the type of the data.												
S	t	A	T	(SP)	(SP)	0x53	0x74	0x61	0x74	0x20	0x20	Error status
[E1-E4] (4 characters) Represents the type of the error.												
(SP)	H	(SP)	(SP)	(SP)	(SP)	0x20	0x48	0x20	0x20	0x20	0x20	OVER ERROR: In excess of the maximum capacity or maximum number of displayable digits.

6-4 Input command

Note

Commands input during the balance being busy (function setting, zero-point adjustment, tare subtraction, calibration etc.) are not accepted.

Reference

Inputting command is available only through D-sub9P connector.

6-4-1 Transmission procedure

1

Send an input command from an external device to the balance.

The table below shows the enable/disable of input commands in each measuring mode.

Measuring mode	Commands		
	Zero-point adjustment, Tare subtraction, Date/Time output	Output control, Comparator setting, Preset tare setting, Interval time setting	External contact input
Weighing	x	x	x
Counting	x	x	x
Percentage	x	x	x
Multiply	x	x	x
Specific gravity	x	-	x

2

Upon successful completion of an input command, the balance will send either a normal completion response or the result data requested by the command to the external device.

- If the operation has not resulted in successful completion, or if the command is invalid (an error), the balance will transmit an error response.
- When the balance is in normal display mode, it usually sends a response to a command within one second of receiving the command. For the tare subtraction and zero-point adjustment, a response is sent after the commands are completely processed.

Note

- (1) After you have sent an input command, the balance return the response command approximately in 1 second.
- (2) Do not send another command to the balance until the external device receives a response from the balance.
- (3) If the balance receives a command when you are setting a function, when the balance is under span adjustment, or the balance is busy for other reasons, the command is ignored.

Reference

In the case that <17 WT STABLE> is <ON>, the balance waits the weighing stability after receiving Tare-subtraction command/Zero-point adjustment command, so the balance may need additional response time.



For verified balance, <17 WT STABLE> is fixed to <ON> and the balance always waits the weighing stability after receiving such a command.

6-4-2 Input command composition 1

Composed of four characters including a terminator (CR=0x0D/LF=0x0A).

1	2	3	4
C1	C2	CR	LF

6-4-2 (1) Zero-point adjustment/Tare/Output control setting command

Note

Please take care not to take alphabetical "O" for Arabic number "0".

C1	C2	Code (C1)	Code (C2)	Description	Response			
					A00/Exx format	ACK/NAK format		
T	(SP)	0x54	0x20	Zero-point adjustment/Tare subtraction	A00: Normal response	ACK: Normal response		
Z	(SP)	0x5a	0x20	Zero-point adjustment				
O	0	0x4f	0x30	Stop output.				
O	1	0x4f	0x31	Continuous output at all times				
O	2	0x4f	0x32	Continuous output at stable times (Output stop at unstable times)				
O	3	0x4f	0x33	Push down [Output] key for one-time instant output.				
O	4	0x4f	0x34	Auto output				
O	5	0x4f	0x35	One-time output at stable times (Output stop at unstable times)				
O	6	0x4f	0x36	One-time output at stable times (Continuous output at unstable times)				
O	7	0x4f	0x37	Push down [Output] key for one-time output at stable times.			E01: Abnormal response	NAK: Abnormal response
O	8	0x4f	0x38	One-time instant output				
O	9	0x4f	0x39	One-time output after stability is obtained				
O	A	0x4f	0x41	Interval function (Output once each time the output time has elapsed)				
O	B	0x4f	0x42	Interval function (Output once during stabilization, each time the output time has elapsed)				

- Reference**
- (1) Commands O8 and O9 are used to request data from the balance.
 - (2) Once the O0 to O7 commands are executed, that state is maintained. However, the status is reset to the setting menu when the balance is turned on again.
 - (3) When the OA or OB command is input, the interval function starts, and when input again, the interval function ends.
 - (4) After the O8 or O9 command is executed, it returns to "O0."

6-4-2 (2) Date output request and time output request

C1	C2	Code (C1)	Code (C2)	Description	Response
D	D	0x44	0x44	Date output request	Date data
D	T	0x44	0x54	Time output request	Time data

6-4-3 Input command composition 2

Composed of 15 characters including a terminator (CR=0x0D/LF=0x0A)

1	2	3	4	5	6	7	8	9	10	11	12	13	14	15
C1	C2	,	C3	C3	C3	C3	C3	C3	C3	C3	C3	C3	CR	LF

(1) 'C3' is maximum ten-digit (including the polarity +/-, comma and point) numeric data.

Example) Upper limit input 120.0000g: "LA,120.0000"

Preset tare input 100.0000g: "PT,100.0000"

Interval time input 12:34:56: "IA,12,34,56" (marked off by commas)

(2) Make sure not input the measuring unit (mg, g, ct, etc.).

(3) Input the command when Weighing mode, Percentage mode, Counting mode or Multiplied by Coefficient mode is operating.

Reference

If it is input while the other mode operation, the balance output an abnormal response.

(4) If the input value is invalid, the balance output an abnormal response.

(5) When the normal response, the preset tare value is input in <321 PRESET 1> and the balance operates Preset tare.

(6) If the input value is "0" at Preset tare setting value command, the preset tare operation is canceled.

6-4-3 (1) Comparator setting command

C1	C2	Code (C1)	Code (C2)	Description	C3	Response	
						A00/Exx format	ACK/NAK format
L	A	0x4C	0x41	Upper limit value setting	Numeric value setting	A00: Normal response E01: Abnormal response	ACK: Normal response NAK: Abnormal response
L	B	0x4C	0x42	Lower limit value setting	Numeric value setting		
L	C	0x4C	0x43	Reference value setting	Numeric value setting		

6-4-3 (2) Preset tare value setting command

C1	C2	Code (C1)	Code (C2)	Description	C3	Response	
						A00/Exx format	A00/Exx format
P	T	0x50	0x54	Preset tare value setting	Numeric value setting	A00: Normal response E01: Abnormal response	ACK: Normal response NAK: Abnormal response

(1) When the normal response, the preset tare value is input in <321 PRESET 1> and the balance operates Preset tare.

(2) If the input value is "0" at Preset tare setting value command, the preset tare operation is canceled.

6-4-3 (3) Interval (output) time setting command

C1	C2	Code (C1)	Code (C2)	Description	C3	Response	
						A00/Exx format	A00/Exx format
I	A	0x49	0x41	Interval (output) time setting	Numeric value setting	A00: Normal response E01: Abnormal response	ACK: Normal response NAK: Abnormal response

6-5 Response

6-5-1 Response command format (“A00”/“Exx” format)

Consists of five characters including terminators.

1	2	3	4	5
A1	A2	A3	CR	LF

6-5-1(1) Response command

A1	A2	A3	code(A1)	code(A2)	code(A3)	Description
A	0	0	0x41	0x30	0x30	Normal response
E	0	1	0x45	0x30	0x31	Abnormal response

6-5-2 Response command format (“ACK”/“NAK” format)

Consists of one character without a terminator.

1
A1

6-5-2(1) Response command

A1	code(A1)	Description
ACK	0x06	Normal response
NAK	0x15	Abnormal response

6-6 External contact input

DIN8P Connector can execute tare subtraction or zero-point adjustment from an external device by connecting a contact or a transistor switch between the pin for tare subtraction (DIN8P Pin 1) and the signal ground pin (Pin 5). When doing so, allow at least 400 ms for connection (ON) time (Maximum voltage: 15 V when the balance is turned OFF, sink current: 20 mA when it is turned ON).

Reference

- (1) While external contact input is selected, command input is not available.
- (2) There is no response command corresponding to external contact input.
- (3) When the load is within the zero-point adjustment range, zero-point adjustment is executed. When the load exceeds the zero-point adjustment range, tare-subtraction is executed. (Refer to “2-2-1 Zero-point adjustment range” for zero-point adjustment range)

6-7 Communication setting

Legal Metrology

For verified balance:

- Setting menu <412 FORMAT> is not available. That is fixed to <CBM> (Generic format) and output formats <6>, <7>, <8>, <CSP6> and <CSP7> are not available;
- Output conditions <413 CONDITION 1, 3, 6> are not available;
- Setting menus <41A STATUS> is not available. That is fixed to <ON> and the net value status is always appended.

1 Select the RS-232C communication operation.

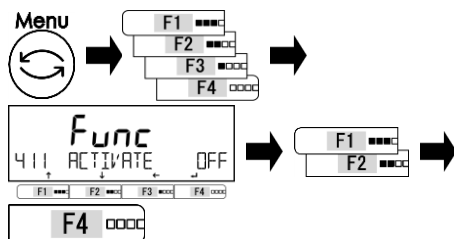

Push [Menu] key, then push [F1-F4] keys to go to <411 ACTIVATE>.

Push [F4] key to change the setting value.

Push [F1/F2] key to select.

OFF: Stop

ON: Operation

Push [F4] key to fix.

2

Select the communication setting.

Refer to the step 1 to key operation for setting.

Select the communication condition.		
4 12 FORMAT		
Set list		
7 : Shinko format 7 digits	8 : Shinko format 8 digits	CSP 7 : CSP 7-digit format
CBM : CBM format	MF : Special format MF	SF16 : Special format SF16
SF22 : Special format SF22		

Select the output conditions.		
4 13 CONDITION		
Set list		
0 : Output stop	1 : Continuous output at all times	2 : Continuous output at stable times (Output stop at unstable times)
3 : Push down [Output] key for one-time instant output.	4 : Auto output	5 : One-time output at stable times (Output stop at unstable times)
6 : One-time output at stable times (Continuous output at unstable times)	7 : Push down [Output] key for one-time output at stable times	

Select the comparator output.	
4 14 COMPARE	
Set list	
0 : As per the output setting	1 : Output when discrimination result is OK or absent

Select the baud rate.		
4 15 BAUD RATE		
Set list		
1200 : 1200 bps	2400 : 2400 bps	4800 : 4800 bps
9600 : 9600 bps	19200 : 19200 bps	38400 : 38400 bps
57600 : 57600 bps	115.2 k : 115200 kbps	

Select the parity bit.		
4 16 PARITY		
Set list		
OFF : None	ODD : Odd number	EVEN : Even number

Select the stop bit.		
4 17 STOP BIT		
Set list		
1BIT : 1 bit	2BIT : 2 bit	

Select unused high order digit.	
4 18 BLANK	
Set list	
ZERO : Filled with 0 (0x30)	SPACE : Filled with a blank space (0x20)

Select the response command format.		
4 19 RESPONSE		
Set list		
1 : "A00/Exx" format	2 : "ACK/NAK" format	

Select the net value status.		
4 1A STATUS		
Set list		
OFF : Not append	ON : Append	

Select the time stamp setting.		
4 1B TIME STAMP		
Set list		
OFF : Not append	ON : Append	

7 Functions related to the lock

Impose limitations on key operation and accessing the menu items, etc.

7-1 Hierarchy of functions related to the lock

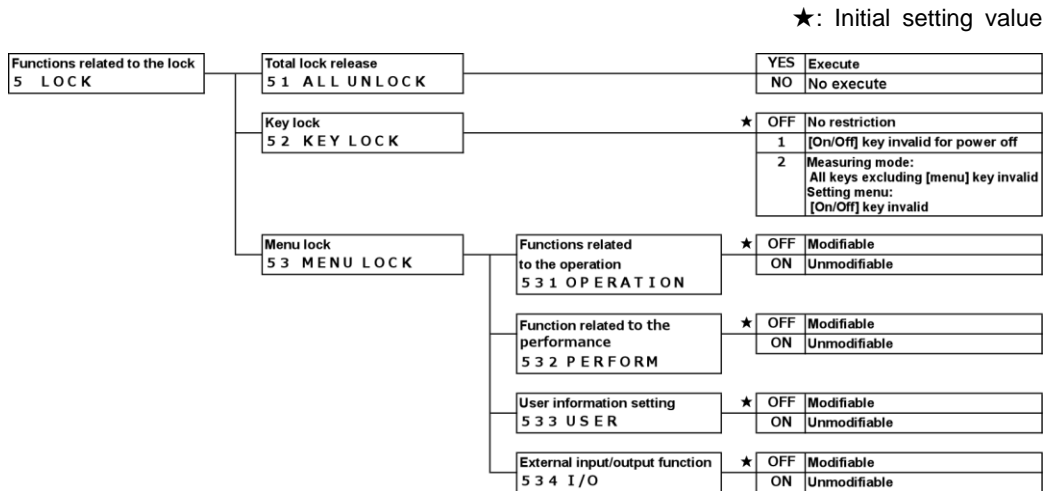

7-2 Total lock release

All locks that have been set can be released.

1 Select the total lock release.

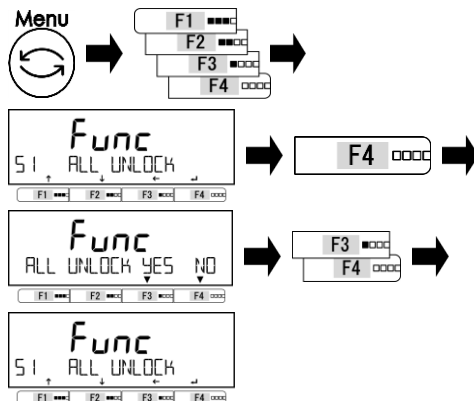

Push [Menu] key, then push [F1-F4] keys to go to <51 ALL UNLOCK>.

Push [F4] key.

Push [F1/F2] key to select.

YES: Execute

NO: NO execute

Unlock all the settings.

2 Exit the setting menu.

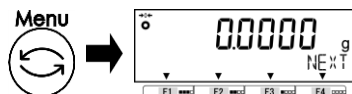

Push [Menu] key to shift to the measuring mode.

7-3 Key lock function

Key operation can be locked.

1 Select the key lock function.

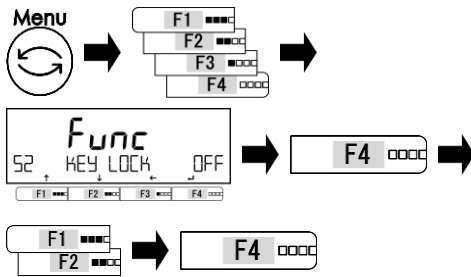

Push [Menu] key, then push [F1-F4] keys to go to <52 KEY LOCK>.

Push [F4] key to change the setting value.

Push [F1/F2] key to select.

OFF: No restriction

1: [On/Off] key invalid for power off

Measuring indication:

All keys excluding [Menu] key invalid

2:

Setting menu:

[On/Off] key invalid

Push [F4] key to fix.

2 Exit the setting menu.

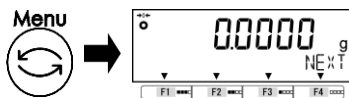

Push [Menu] key to shift to the measuring mode.

7-4 Menu lock function

Various setting menus can be locked.

1 Select the menu lock function.

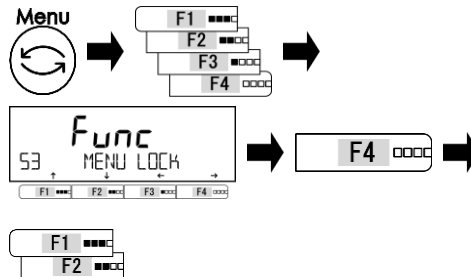

Push [Menu] key, then push [F1-F4] keys to go to <53 MENU LOCK>.

Push [F4] key to change.

Push [F1/F2] key to select.

Refer to Set List.

Set list	
531 OPERATION : Function related to the operation <1 APPLICATIONS>	532 PERFORM : Function related to the performance <2 PERFORMANCE>
533 USER : User information setting <3 USER INFO>	534 I/O : External input/output functions <4 EXTERNAL I/O>

2 Select modifiable/unmodifiable of each menu.

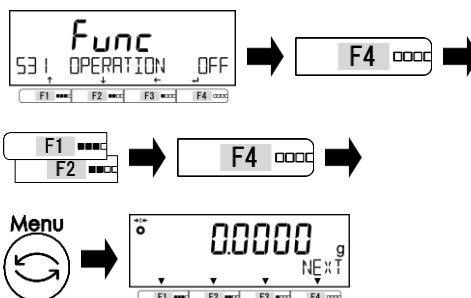

Push [F4] key to change the setting value.

Push [F1/F2] key to select.

OFF: Modifiable

ON: Unmodifiable

Push [F4] key to fix.

Push [Menu] key to shift to the measuring mode.

8 Controlling and adjustment functions

Perform setting of the balance ID, the span adjustment/test and the date and time.

8-1 Hierarchy of controlling and adjustment functions

Reference

- (1) <ICAL> of <61* F* KEY>, <633 INT CAL>, <634 INT SPAN TEST>, <635 ARM>, <636 REF CAL>, <637 REF CAL RESTORE>, <AUTO> of <638 ADVICE CAL> and <64B START CAL> are available only on the models with internal calibration weight (HTRCEN).
- (2) The initial setting value of <621 F1 KEY> / <638 ADVICE CAL > is:
 - <CAL> / <OFF> for model without internal calibration weight (HTCEN);
 - <ICAL> / <AUTO> for model with internal calibration weight (HTRCEN).

Legal Metrology

- (1) For verified balance, gray shaded items () are not indicated.
- (2) <CAL> of <62* F* KEY> and <631 EX CAL> may not be available for verified balance in several countries in compliance with the national raw.

★: Initial setting value

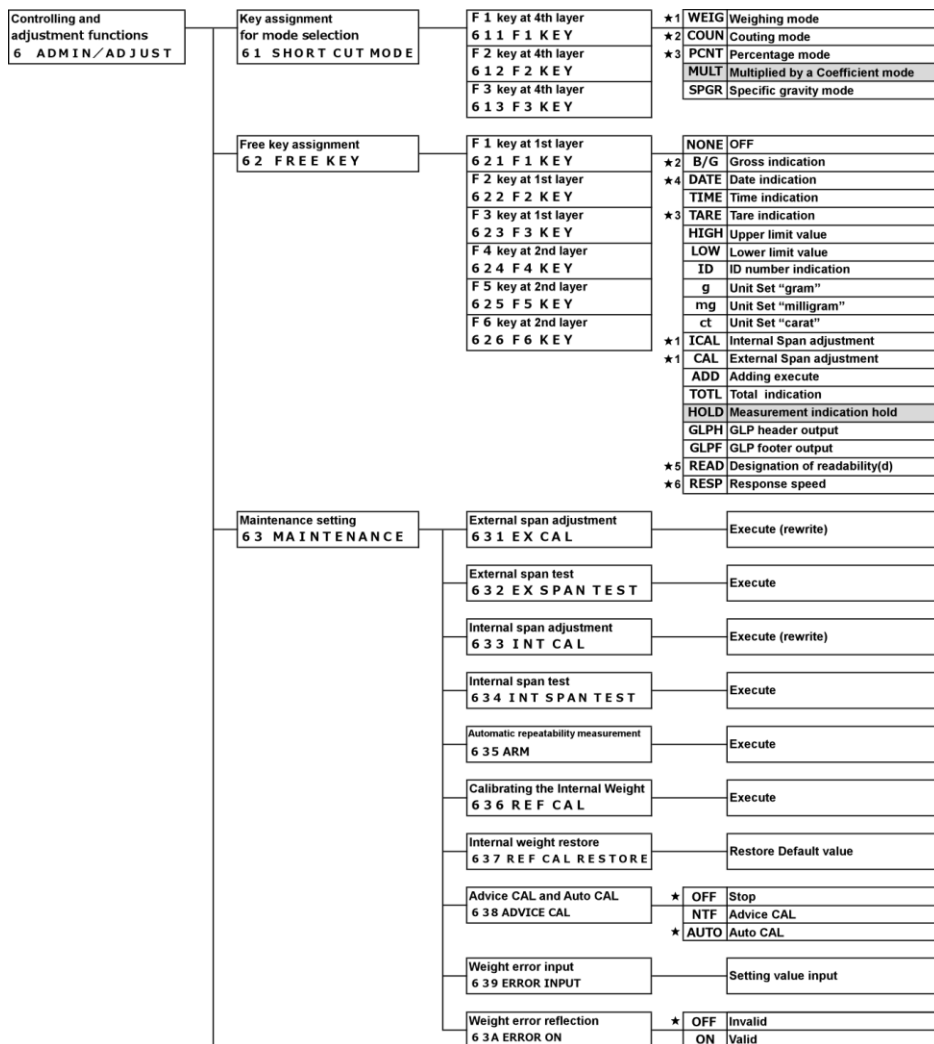

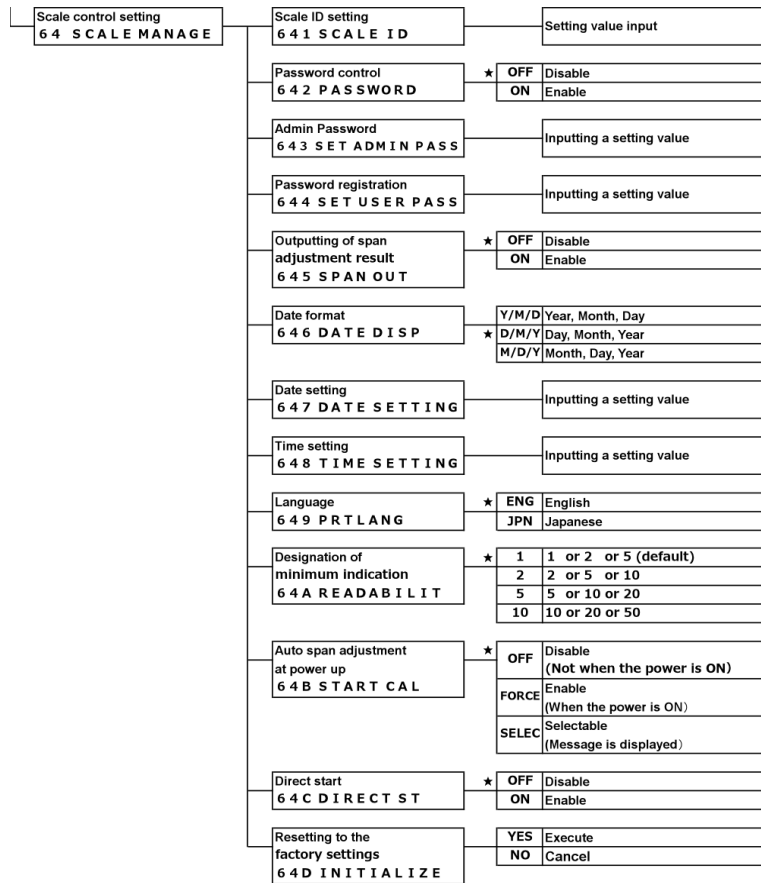

8-2 Shortcut setting for accessing various measuring modes

Shortcuts for various measuring mode can be assigned to <<F1-F3>> which are displayed above [F1-F3] key.

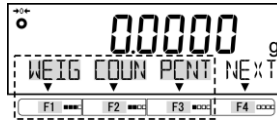

For verified balance, only Weighing mode <WEIG>, Counting mode <COUN>, Percentage mode <PCNT> and Specific gravity mode <SPGR> can be selected. Multiplied by Coefficient mode <MULT> cannot be selected.

1 Select <<F1-F3>>.

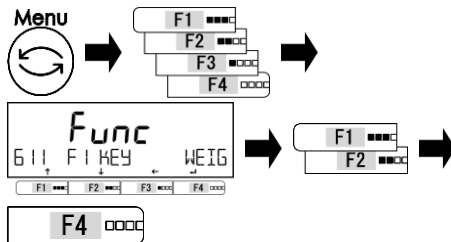

Push [Menu] key, then push [F1-F4] keys to go to <611 F1 KEY>.

Push [F4] key to change.

Push [F1/F2] key to select.

611 F1 KEY: <<F1>> above [F1] key

612 F2 KEY: <<F2>> above [F2] key

613 F3 KEY: <<F3>> above [F3] key

Push [F4] key to fix.

2 Select the measuring modes.

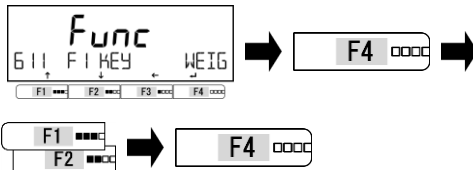

Push [F4] key to change the setting value.

Push [F1/F2] key to select.

Refer to Set List.

Push [F4] key to fix.

Set list		
WEIG : Weighing mode	COUN : Counting mode	PCNT : Percentage mode
MULT : Multiplied by Coefficient mode	SPGR : Specific gravity mode	

3 Exit the setting menu.

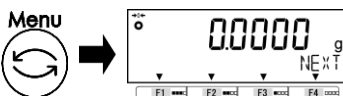

Push [Menu] key to shift to the measuring mode.

4 Use shortcut

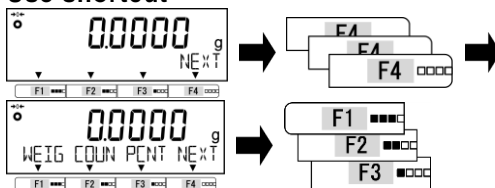

Push [F4] key several times to shift to the shortcut display.

Push [F1], [F2] or [F3] key to shift to each measuring mode.

8-3 Free key setting

Reference

- (1) Free key setting is valid only in the weighing mode.
- (2) <ICAL>, <GLPH> and <GLPF> are available only on the models with internal calibration weight (HTRCEN).

Legal Metrology

- (1) <CAL> may not be available for verified balance in several countries in compliance with the national law.
- (2) <HOLD> cannot be selected for verified balance.

Various function can be assigned to the <<F1-F6>> (Free key), which are displayed above the [F1-F3] keys.



Display1 (<<F1-F3>>)



Display2 (<<F4-F6>>)

1 Select the <<F1-F6>> setting menu.

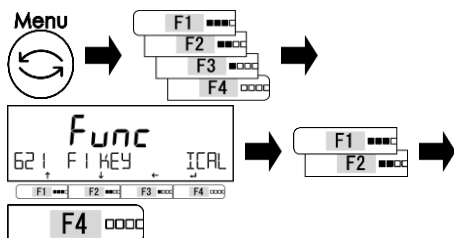

Push [Menu] key, then push [F1-F4] keys to go to <621 F1 KEY>.

Push [F1/F2] key to select each Free key setting menu.

Refer to "Free key setting menu list".

621 F1 KEY : <<F1>>	622 F2 KEY : <<F2>>	623 F3 KEY : <<F3>>
624 F4 KEY : <<F4>>	625 F5 KEY : <<F5>>	626 F6 KEY : <<F6>>

2 Select the function to assign to the Free key.

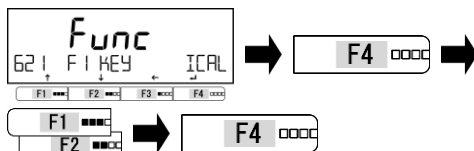

Push [F4] key to change the setting value.

Push [F1/F2] key to select.

Refer to Set List.

Push [F4] key to fix.

NONE : OFF	B/G : Gross indication
DATE : Date indication	TIME : Time indication
TARE : Tare value indication	HIGH : Upper limit value
LOW : Lower limit value	ID : ID number indication
g : Unit set "gram"	mg : Unit set "milligram"
ct : Unit set "carat"	ICAL : Internal span adjustment
CAL : External span adjustment	ADD : Adding execute
TOTL : Total indication	HOLD : Measurement indication hold
GLPH : GLP header output	GLPF : GLP footer output
READ : Designation of readability(d)	RESP : Response speed

3 Exit the setting menu.

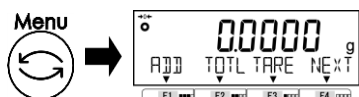

Push [Menu] key to shift to the weighing mode.

8-4 Maintenance settings

8-4-1 Span adjustment and span test

Span adjustment is to “decrease” the difference between an indicated value and the true value (mass), and span test is to “check” the difference between an indicated value and the true value.

This must be performed without fail in the case of doing high-accuracy weighing work.

Because an electronic balance is affected by the acceleration of gravity, adjustment/test is needed at every weighing location. The adjustment/test is also needed when (1) using a long period and (2) an accurate indication does not appear any longer.

When “Advice CAL” is activated, the balance generates an alarm when calibration is needed.

Note

- (1) An external weight used for the span adjustment shall be the one equivalent to the OIML E2 class.
- (2) The span adjustment significantly affects the weighing accuracy. Please read this procedure carefully before getting to the adjustment.

8-4-1(1) Span adjustment with external weight

Legal Metrology

This mode may be unavailable for verified balance in accordance with the regulation of your country. When span adjustment by external weight is prohibited even for Class I balance, the error indication appears if you try to execute this function.

Reference

Free key <<CAL>> (span adjustment with external weight) is assigned to <<F1>> on the models without internal calibration weight (HTCEN).

1 Select the span adjustment with external weight. Push [Menu] key, then push [F1-F4] keys to go to <631 EX CAL>. Push [F4] key to execute.

2 Select the minimum interval for rounding the weight of the external weight. Push [F1/F2] key to select

- 1: 0.0001 g
- 2: 0.0002 g
- 5: 0.0005 g
- 10: 0.001 g

Push [F1/F2] key to fix.

3 Select a weight used for the span adjustment. Push [F1/F2] key and select a weight used for the span adjustment. (Refer to List of “weights used for the span adjustment by model”) Push [F4] key to fix.

4 Zero-point adjustment starts. Display changes to the order of <on 0> → “blinking of <on 0>”. On completion of the zero-point adjustment, the display automatically changes to <on FS>.

5 The span adjustment starts.

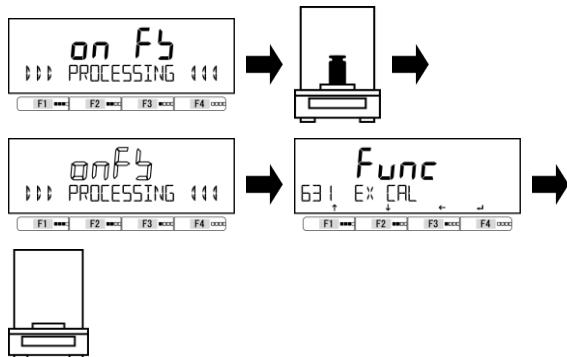

Place the weight in the center of the weighing pan.

Display changes to the order of <on FS> → “blinking of <on FS>”.

Start of the span adjustment.

On completion of the span adjustment, the display automatically changes to <631 EX CAL>.

Unload the weight from the weighing pan.

6 Exit the setting menu.

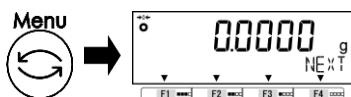

Push [Menu] key to shift to the measuring mode.

(1) List of weights used for the span adjustment by model (Unit: g).

Model	HT84(R)CEN	HT124(R)CEN	HT224(R)CEN
Selectable weight on the menu	80	120	220
VAR set	1 to 80	1 to 120	1 to 220

(2) The span adjustment by the use of a weight less than the weighing capacity may possibly indicate <UC> on the display. When this is the case, the weighing accuracy is not guaranteed.

Conditions under which <UC> is indicated;

- When a sample that is more than two times heavier than the weight that was used for the span adjustment is weighed, and
- When the readability (minimum indication) setting <64A READABILIT>, which is finer than the minimum interval for rounding setting <SELECT MIN> selected for the span adjustment, is performed.



Reference

(3) When the external calibration weight has error in mass, it is preferred to calibrate the balance with the corrected mass.

Please refer to “8-4-6 Correction of the external calibration weight”.

8-4-1(2) Span test with external weight

Note

Make sure to use the external weight which is equal to the weighing capacity of each model.

1 Select the span test with external weight.

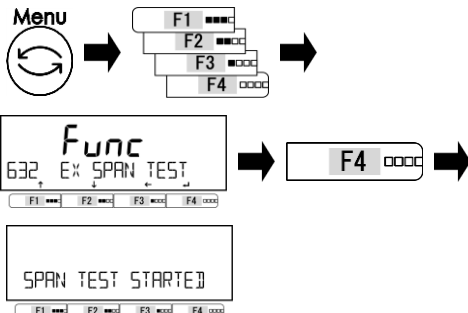

Push [Menu] key, then push [F1-F4] keys to go to <632 EX SPAN TEST>. Push [F4] key to execute.

2 Zero-point adjustment starts.

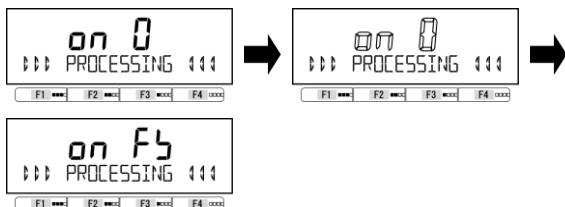

Display changes to the order of <on 0> → “blinking of <on 0>”. On completion of the zero-point adjustment, the display automatically changes to <on FS>.

3 The span test starts.

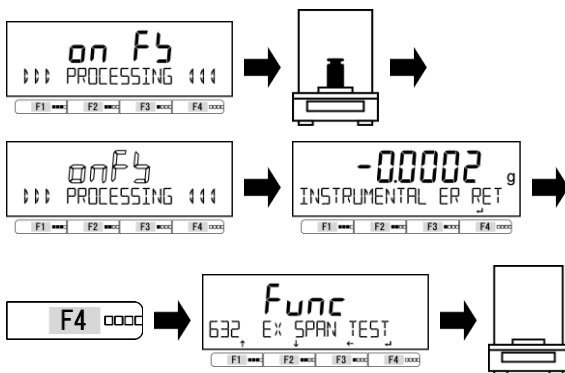

Place the weight in the center of the weighing pan. Display changes to the order of <on FS> → “blinking of <on FS>”. Start of the span test. On completion of the span test, the display automatically changes to < INSTRUMENTAL ER> and the instrumental error of the balance is displayed. Push [F4] key. <632 EX SPAN TEST> is displayed. Unload the weight from the weighing pan.

4 Exit the setting menu.

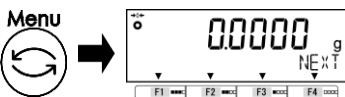

Push [Menu] key to shift to the measuring mode.

Reference

When the external calibration weight has error in mass, it is preferred to execute span test with the corrected mass. Please refer to “8-4-6 Correction of the external calibration weight”.

8-4-1(3) Semi-Automatic Span adjustment with internal weight

Note

Do not power-off the balance while this function is operating.

Reference

- (1) This function is available only on models with internal calibration device (HTRCEN).
- (2) Free key <<CAL>> (span adjustment with internal weight) is assigned to <<F1>> on the models with internal calibration weight (HTRCEN).

1 Select the span adjustment with internal weight.

Push [Menu] key, then push [F1-F4] keys to go to <633 INT CAL>. Push [F4] key to execute.

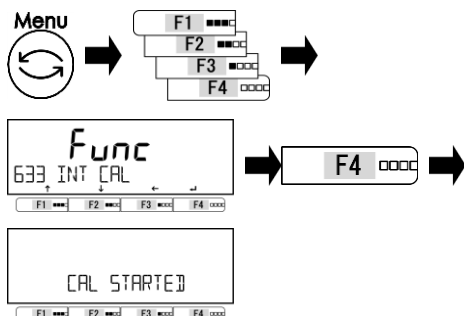

2 The span adjustment starts.

Display changes to the order of <Ch 0> → “blinking of <Ch 0>” → <Ch FS> → “blinking of <Ch FS>” → <633 INT CAL>.

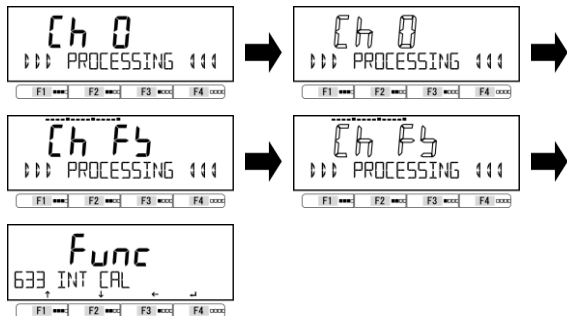

3 Exit the setting menu.

Push [Menu] key to shift to the measuring mode.

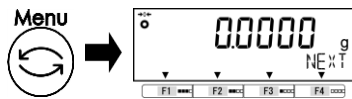

8-4-1(4) Span test with internal weight

Note

Do not power-off the balance while this function is operating.

Reference

This function is available only on models with internal calibration device (HTRCEN).

1 Select the span test with internal weight.

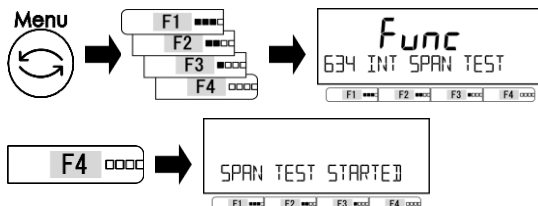

Push [Menu] key, then push [F1-F4] keys to go to <634 INT SPAN TEST>. Push [F4] key to execute.

2 The span test starts.

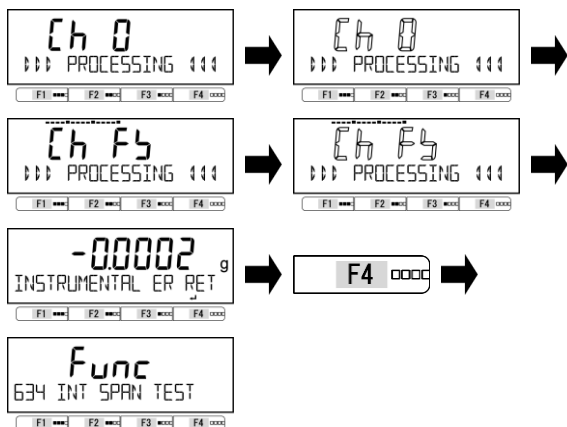

Display changes to the order of <Ch 0> → “blinking of <Ch 0>” → <Ch FS> → “blinking of <Ch FS>” → < INSTRUMENTAL ER> and the instrumental error of the balance is displayed. Push [F4] key. <634 INT SPAN TEST> is displayed.

3 Exit the setting menu.

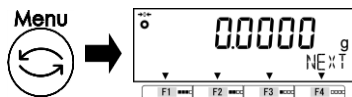

Push [Menu] key to shift to the measuring mode.

8-4-2 Automatic Repeadability Measurement (ARM)

This is a function to calculate a standard deviation by loading and unloading the built-in weight for 10 times.

Note

Do not power-off the balance while this function is operating.

Reference

This function is available only on models with internal calibration device (HTRCEN).

1 Select the span test with internal weight.

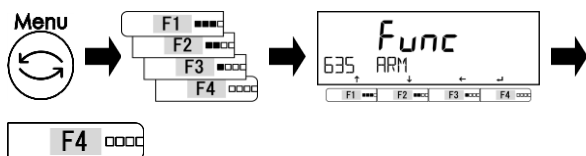

Push [Menu] key, then push [F1-F4] keys to go to <635 ARM>. Push [F4] key to execute.

2 Automatic repeadability measurement starts.

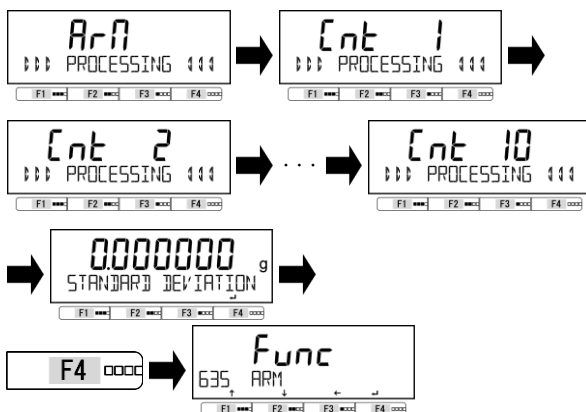

Display changes to the order of <ArM> → <Cnt 1> → <Cnt 2> → ... → <Cnt 10>, then the standard deviation is displayed. Push [F4] key. <635 ARM > is displayed.

3 Exit the setting menu.

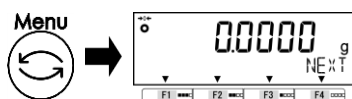

Push [Menu] key to shift to the measuring mode.

8-4-3 Calibrating the internal weight

Use this function to calibrate the internal weight by external weight.

Note

- (1) To calibrate more accurately, use a weight that is equivalent to the weighing capacity (Max).
- (2) An external weight used for the span adjustment shall be the one equivalent to the OIML E2 class.
- (3) The calibrating the internal weight significantly affects the weighing accuracy. Please read this procedure carefully before getting to the adjustment.
- (4) Do not power-off the balance while this function is operating.

Reference

This function is available only on models with internal calibration device (HTRCEN).

1 Select the calibration of the internal weight.

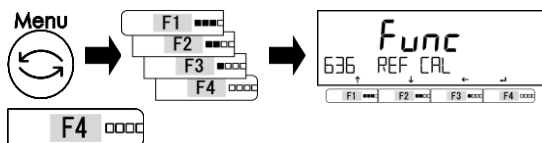

Push [Menu] key, then push [F1-F4] keys to go to <636 REF CAL>. Push [F4] key to execute.

2 Zero-point adjustment starts.

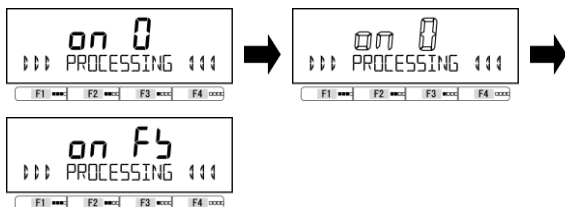

Display changes to the order of <on 0> → “blinking of <on 0>”. On completion of the zero-point adjustment, the display automatically changes to <on F5>.

3 The span adjustment starts.

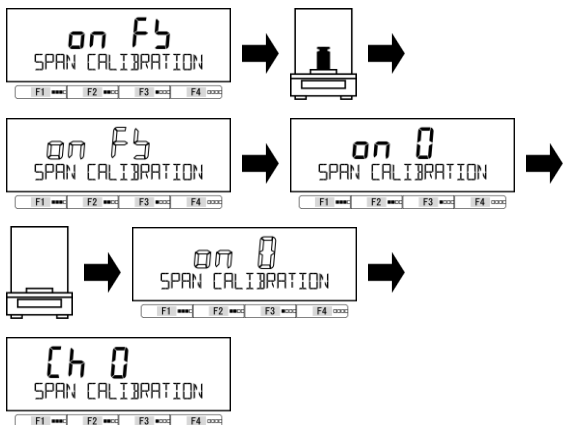

Place the weight in the center of the weighing pan. Display changes to the order of <on FS> → “blinking of <on FS>”. Start of the span adjustment. On completion of the span adjustment, the display automatically changes to <on 0>. Unload the weight from the weighing pan. Display automatically changes to “blinking of <on 0>” and zero-point adjustment starts. On completion of the zero-point adjustment, the display automatically changes to “blinking of <Ch 0>”.

4 The calibrating the internal weight starts.

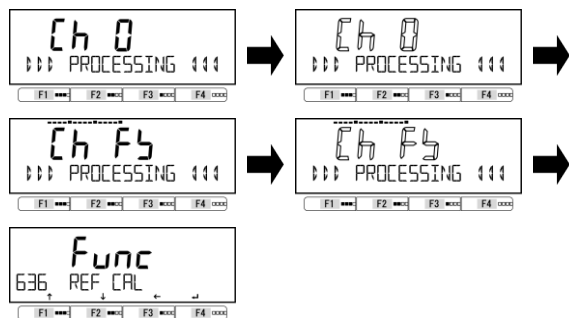

Display changes to the order of “blinking of <Ch 0>” → <Ch FS> → “blinking of <Ch FS>”.
On completion of the calibrating the internal weight, the display automatically changes to <636 REF CAL>.

5 Exit the setting menu.

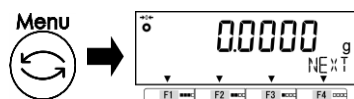

Push [Menu] key to shift to the measuring mode.

8-4-4 Restore the internal weight calibration value to default

Reference

This function is available only on models with internal calibration device (HTRCEN).

1 Select the restore.

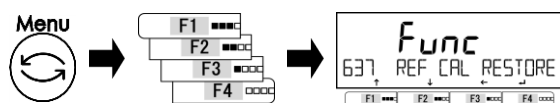

Push [Menu] key, then push [F1-F4] keys to go to <637 REF CAL RESTORE>.

2 Execute the restore.

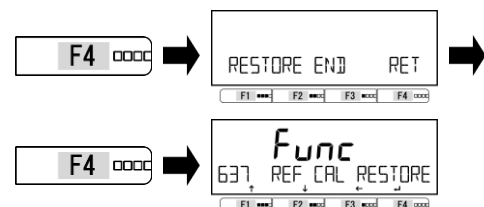

Push [F4] key to execute.

The internal weight calibration value is restored to default (factory setting).
Push [F4] key.

<637 REF CAL RESTORE> is displayed.

3 Exit the setting menu.

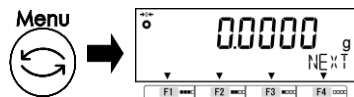

Push [Menu] key to shift to the measuring mode.

Note

For accurate calibration, please execute calibration of internal weight by referring '8-4-3 Calibrating the internal weight'

8-4-5 Advice CAL and Automatic span adjustment

8-4-5(1) Advice CAL

The balance generates an alarm when calibration is needed.



For models without internal calibration device (HTCEN), this function is not available in several countries where the span adjustment with external weight is prohibited even for Class I balances.

1 Select the Advice CAL.

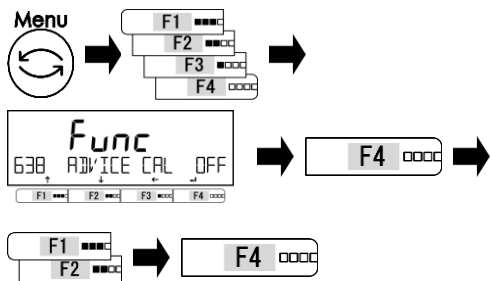

Push [Menu] key, then push [F1-F4] keys to go to <638 Advice CAL >, and then push [F4] key to change the setting.

Push [F1/F2] key to select <NTF>.

OFF: Disable

NTF: Advice CAL

AUTO: Auto CAL

Push [F4] key to fix.

2 Exit the setting menu.

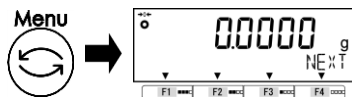

Push [Menu] key to shift to the measuring mode.

3 Message appears when span adjustment is needed.

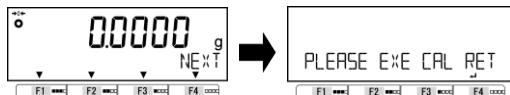

A message appears when time passed since power-on or last span adjustment, or temperature / atmospheric pressure changed.

4 Return to the weighing mode and execute span adjustment.

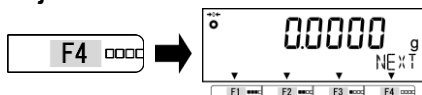

Push [F4] key to shift to the measuring mode.

Then execute span adjustment with external weight (8-4-1(1)) or semi-automatic span adjustmet with internal weight (8-4-1(3)).

➡ 8-4-1(1)Span adjustment with external weight

or

8-4-1(3)Semi-automatic span adjustment with internal weight

8-4-5(2) Automatic Span Adjustment

When the automatic span adjustment is activated, the balance automatically starts span adjustment by detecting temperature change or time course.

Note

This function is available only on models with internal calibration device (HTRCEN).

1 Select the Advice CAL.

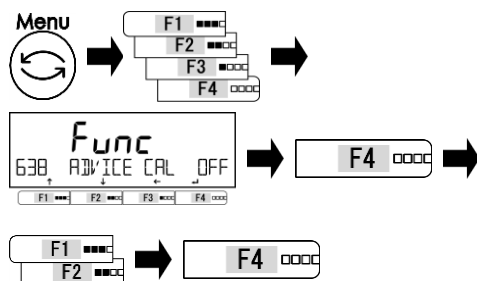

Push [Menu] key, then push [F1-F4] keys to go to <638 Advice CAL >, and then push [F4] key to change the setting.

Push [F1/F2] key to select <AUTO>.

OFF: Disable

NTF: Advice CAL

AUTO: Auto CAL

Push [F4] key to fix.

2 Exit the setting menu.



Push [Menu] key to shift to the measuring mode.

3 After time passed or the environment changed, internal span adjustment starts automatically.

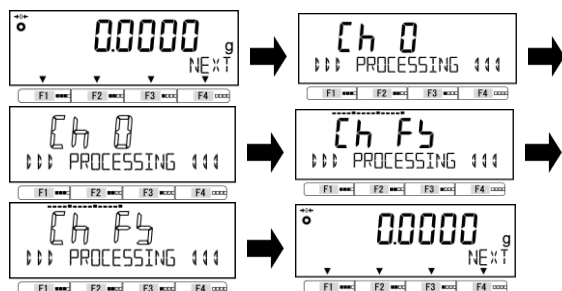

Span adjustment with internal calibration weight starts automatically when:

- Time passed, temperature changed or atmospheric pressure changed; and
- There is no load on the pan and weight indication is stable for 10 minutes.

8-4-6 Correction of the external calibration weight

The error of the external reference weight used for span adjustment/span test can be inputted.

1 Select the weight error input.



Push [Menu] key, then push [F1-F4] keys to go to <639 ERROR INPUT>. Push [F4] key.

2 Input the error of the external reference weight.

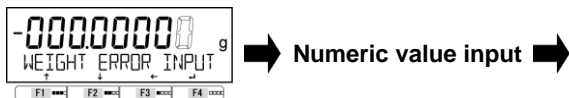

Input the unit weight by using [F1-F3] keys. Push [F4] key to fix.



(Refer to “2-5-3 Numeric value input”)

3 Select the weight error reflection.



Push [F1-F4] keys to go to <63A ERROR ON>.

4 Activate the weight error reflection.

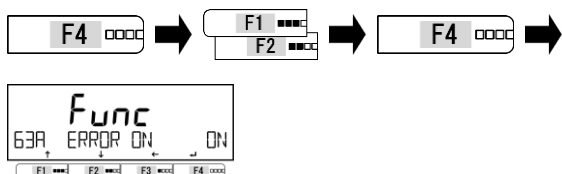

Push [F4] key then push [F1/F2] key to select <ON>. OFF: Invalid ON: Valid Push [F4] key to fix.

5 Execute span adjustment/test with external weight

(Refer to “8-4-1(1) Span adjustment with external weight” and “8-4-1(2) Span test with external weight”.)

Note

The input range of the error of external calibration weight must be between -100 mg and +100 mg.

8-5 Balance control setting

8-5-1 Balance ID setting

A balance ID (Balance ID) can be set to discriminate the balance. The balance ID is output with GLP header output and external span calibration/test result output. Balance ID is checked by free key <<ID>>.

1 Select the balance ID setting.

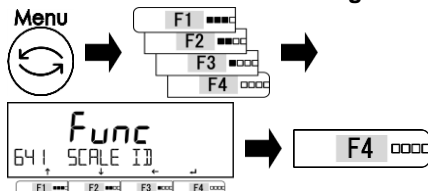

Push [Menu] key, then push [F1-F4] keys to go to <641 BALANCE ID>.

Push [F4] key.

2 Input the balance ID.

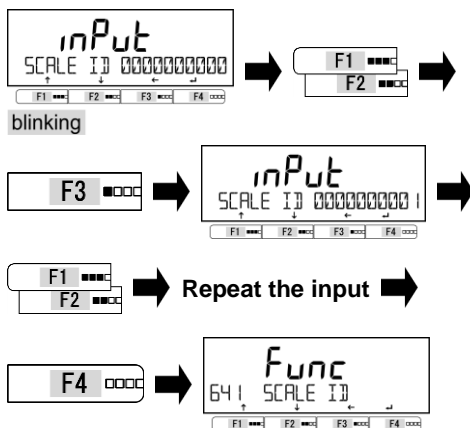

The digit for inputting is blinking.

Push [F1/F2] key to increment/decrement the digit to select.

Push [F3] key to input the next digit.

Push [F1/F2] key.

Repeat the input by the procedure above.

Push [F4] key to fix the balance ID and shift to <641 BALANCE ID>.

3 Exit the setting menu.

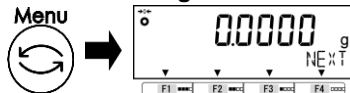

Push [Menu] key to shift to the measuring mode.

8-5-2 Password control

Enable/disable the password protection.

Reference

- (1) Refer to "8-5-2 Administrator password registration" and "8-5-3 User password registration" for password registration/changing.
- (2) Refer to "Appendix 8 Balance operation with password control function" for using the balance with password control.

1 Enable/disable the password protection.

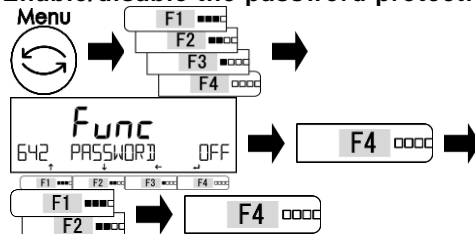

Push [Menu] key, then push [F1-F4] keys to go to <642 PASSWORD>.

Push [F4] key to change.

Push [F1/F2] keys to select;

OFF : Disable

ON : Enable

Push [F4] key to fix.

2 Exit the setting menu.

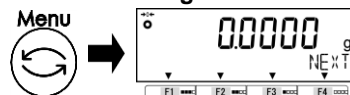

Push [Menu] key to shift to the measuring mode.

Password input display appears from next power on.

8-5-2 (1) Administrator password registration

Note

- (1) Make sure not to forget the administrator password.
- (2) In case that the administrator password is lost, please contact the store where you purchased the product.

Reference

Only one password can be set for administrator.

1 Select the Administrator password registration.

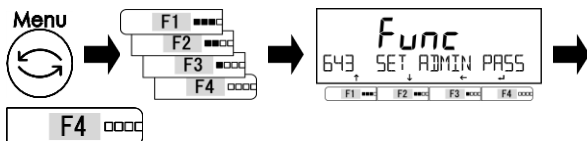

Push [Menu] key, then push [F1-F4] keys to go to <643 SET ADMIN PASS>.

Push [F4] key to input the password.

2 Input the password to register.

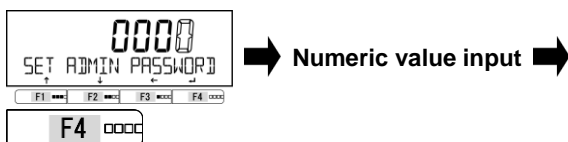

Input to set the password.
Four digits of 0-9 can be selected.
Push [F4] key to fix.

(Refer to “2-5-3 Numeric value input”)

3 Exit the setting menu.

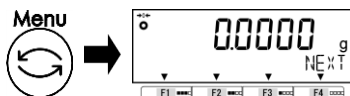

Push [Menu] key to shift to the measuring mode.

8-5-2 (2) User password registration

Administrator can register the user password for each user (operator).

Reference

- (1) Refer to “Appendix 6 Balance operation with password control function” for setting each user’s authority.
- (2) Two users (User 1 and User 2) can be registered.
- (3) User 0 (guest) cannot be assigned a password.

1 Select the User password registration.

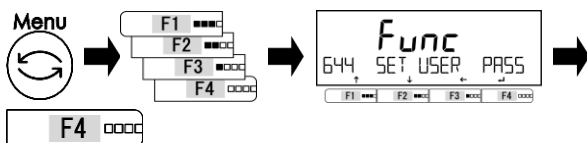

Push [Menu] key, then push [F1-F4] keys to go to <644 SET USER PASS>.

Push [F4] key to input the password.

2 Input the password to register.

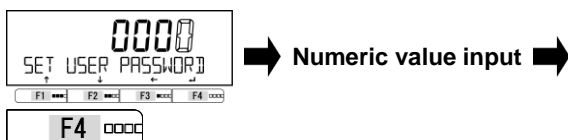

Input to set the password.
Four digits of 0-9 can be selected.
Push [F4] key to fix.

(Refer to “2-5-3 Numeric value input”)

3 Exit the setting menu.

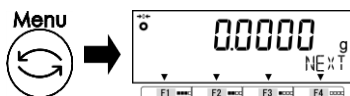

Push [Menu] key to shift to the measuring mode.

8-5-3 Outputting of the span adjustment / test result

After span adjustment/test, the result can be output automatically.

Reference

Make sure to activate <41 RS232C> to output the data.

1 Select the outputting.

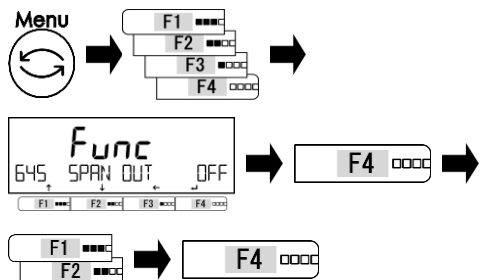

Push [Menu] key, then push [F1-F4] keys to go to <645 SPAN OUT>.

Push [F4] key to change the setting menu.

Push [F1/F2] key to select.

OFF: Disable

ON: Enable

Push [F4] key to fix.

2 Exit the setting menu.

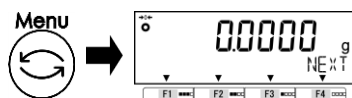

Push [Menu] key to shift to the measuring mode.

8-5-4 Date indication format

Date indication format can be selected.

1 Select the Date indication format.

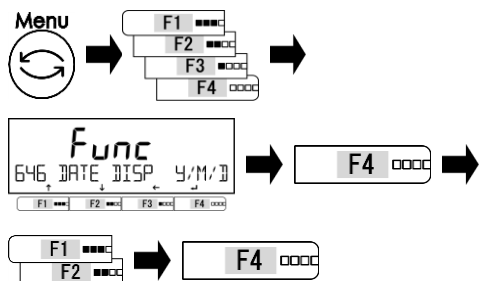

Push [Menu] key, then push [F1-F4] keys to go to <646 DATE DISP>.

Push [F4] key to change the setting value.

Push [F1/F2] key to select.

Y/M/D: Year, Month, Day

D/M/Y: Day, Month, Year

M/D/Y: Month, Day, Year

Push [F4] key to fix.

2 Exit the setting menu.

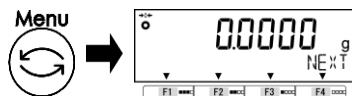

Push [Menu] key to shift to the measuring mode.

8-5-5 Date setting

1 Select the date setting.

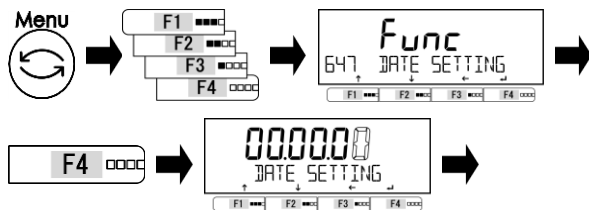

(Refer to “2-5-3 Numeric value input”)

Push [Menu] key, then push [F1-F4] keys to go to <647 DATE SETTING>. Push [F4] key to change the setting value.

The digit for inputting is blinking. Input the date. Push [F4] key to fix the date setting.

2 Exit the setting menu.

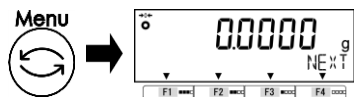

Push [Menu] key to shift to the measuring mode.

3 Indication of the date.



Push [F2] (<DATE>) key.

The date is indicated. Push [F4] key to return to the measuring mode.

8-5-6 Time setting

1

Select the time setting.



Push [Menu] key, then push [F1-F4] keys to go to <648 TIME SETTING>.



Push [F4] key to change the setting menu.

The digit for inputting is blinking.

Input the time.

Push [F4] key to fix the time setting.



(Refer to “2-5-3 Numeric value input”)

2

Exit the setting menu.

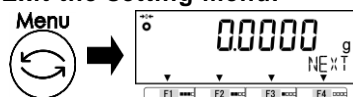

Push [Menu] key to shift to the measuring mode.

3

Indication of the time.



Push [F3] (<TIME>) key.

The time is indicated.

Push [F4] key to return to the measuring mode.

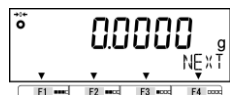

8-5-7 Output language

Output language can be select from two languages; English or Japanese.

1

Select the language.

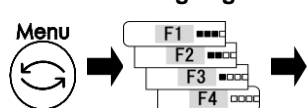

Push [Menu] key, then push [F1-F4] keys to go to <649 PRT LANG>.

Push [F4] key to change the setting value.

Push [F1/F2] key to select.

ENG: English

JPN: Japanese

Push [F4] key to fix.

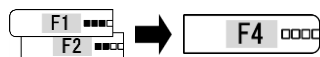
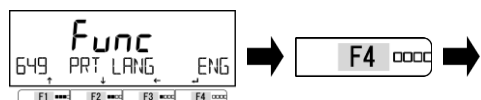

2

Exit the setting menu.

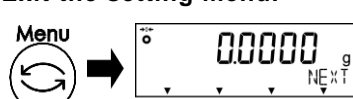

Push [Menu] key to shift to the measuring mode.

Reference

Refer to “6 External input/output functions” for setting to communicate with other devices.

8-5-8 Readability Setting

The larger the readability becomes, the less the balance is affected by external influences. In addition, it takes less time for the balance reading to stabilize.

Reference Refer to "Appendix 1-1 Basic specification" and "Appendix 4 Weighing capacity and readability by unit" for the default readability of each unit.

1 Select the readability setting.

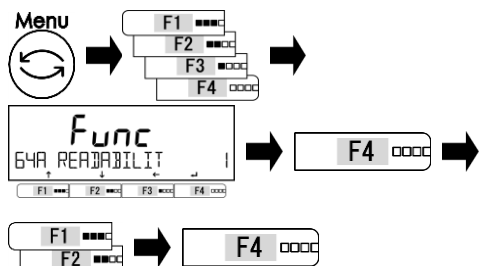

Push [Menu] key, then push [F1-F4] keys to go to <64A READABILIT>.
Push [F4] key to change the setting value.
Push [F1/F2] key to select.

		The default readability		
		1	2	5
Set value	1:	1(default)	2(default)	5(default)
	2:	2	5	10
	5:	5	10	20
	10:	10	20	50

Push [F4] key to fix.

2 Exit the setting menu.

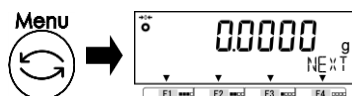

Push [Menu] key to shift to the measuring mode.

8-5-9 Span adjustment with internal weight at power-on

Reference (1) This function is available only on models with internal calibration device HTRCEN.
(2) "Span adjustment with internal weight at power-on" operates first power-on after connection of AC adapter.

1 Select the span adjustment at power-on.

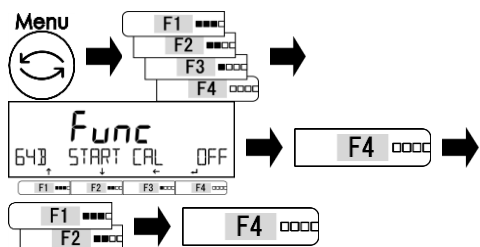

Push [Menu] key, then push [F1-F4] keys to go to <64B START CAL>.
Push [F4] key to change the setting value.
Push [F1/F2] key to select.

- OFF: Disable
- FORCE: Enable
Always when the power is ON.
- SELEC: Selectable
Message is displayed.

Push [F4] key to fix.

2 Exit the setting menu.

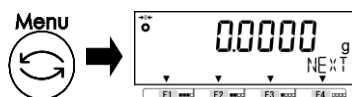

Push [Menu] key to shift to the measuring mode.

3 Operate span adjustment at power-on.

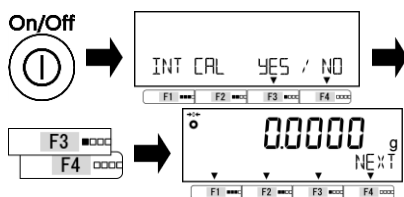

Push [On/Off] key to turn on the balance.
When <SELEC> is selected at step 1, select whether or not execute span adjustment by pushing [F3/F4] key.

- YES: Execute
- NO: Not execute

The balance executes span adjustment by internal weight and then shifts to measuring mode.

Note Do not power-off the balance while span adjustment is operating.

8-5-10 Direct start setting

This is a function to turn on the balance automatically without pushing [On/Off] key when it is connected to the AC power. You can use this function when the balance is used in conjunction with other devices.

1 Select the direct start.

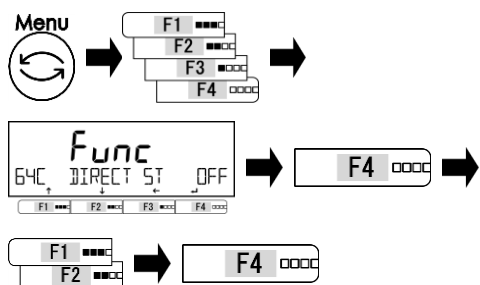

Push [Menu] key, then push [F1-F4] keys to go to <64C DIRECT ST>.

Push [F4] key to change the setting value.

Push [F1/F2] key to select.

OFF: Disable

ON: Enable

Push [F4] key to fix.

2 Exit the setting menu.

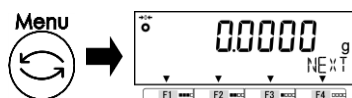

Push [Menu] key to shift to the measuring mode.

8-5-11 Initialize

This function is to initialize the balance to the factory settings except span adjustment, the date and time setting.

1 Select the initialize.

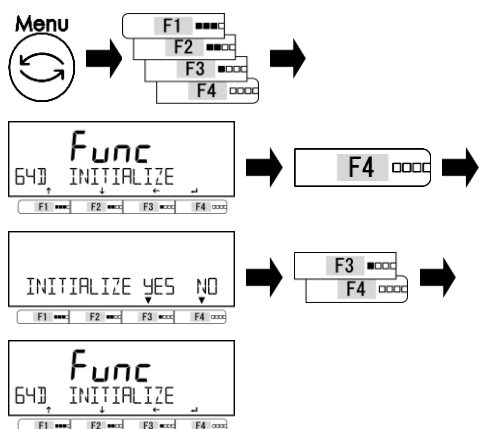

Push [Menu] key, then push [F1-F4] keys to go to <64D INITIALIZE>.

Push [F4] key.

Push [F3/F4] key to select.

NO: Cancel

YES: Execute

<64D INITIALIZE> is displayed.

2 Exit the setting menu.

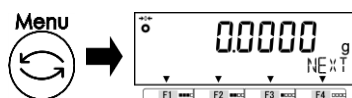

Push [Menu] key to shift to the measuring mode.

9 Troubleshooting

Reference

If the trouble persists after following the procedures below, please contact the store you purchased.

9-1 Error message

Error Message/ Error Code	Cause	Coping method
OVER ERROR	<ul style="list-style-type: none"> - The weight of the sample to be weighed is in excess of the maximum capacity. - The addition result or calculation result has exceeded the maximum number of displayable digits. 	<ul style="list-style-type: none"> - Split the sample into several pieces and weigh them. - Replace the tare with a lighter one. - Clear the calculation result, and then re-execute the addition/computation while being careful of the display digit.
UNDER ERROR	The negative load is below the lower limit.	<ul style="list-style-type: none"> - Improper setting of the weighing pan or pan base is suspected. - Check for contact with other object. Use the dedicated weighing pan and pan base only.
DISPLAY ERROR / DSP OVER	The addition result or calculation result has exceeded the maximum display digit.	Clear the calculation result, and then re-execute the addition/computation while being careful of the display digit.
LOWER ERROR	The unit/reference weight in Counting/Percentage mode is below the lower limit.	Choose the samples of which unit weight/reference weight is larger than the lower limit.
ERR001~ ERR099	System error	Record the error code and notify the store where you purchased the product.
ERR703	<ul style="list-style-type: none"> - The operation key was pushed at the time of starting from the standby status. If the error message is displayed nevertheless the operation key wasn't pushed, there is something wrong with the hardware. 	Do not push the operation key while the balance is in the process of starting from the standby status.
ERR705	Initial zero adjustment error. The initial zero adjustment was not completed in the process of starting from the standby status because of the unstable load.	<ul style="list-style-type: none"> - Improper setting of the weighing pan or pan base is suspected. - Check for contact with other object. - Check for any wind or vibration.
ERR706	The load is out of the initial zero adjustment range.	Do not put any load on the weighing pan at the power-on of the balance.
ERR709 ERR710 ERR711	<ul style="list-style-type: none"> - The load is unstable at the zero adjustment/tare subtraction. - Span adjustment time-out error. 	<ul style="list-style-type: none"> - Improper setting of the weighing pan or pan base is suspected. - Check for contact with other object. - Check for any wind or vibration.
ERR717	The mass of the calibration weight is 1% differ from the designated mass at the external span adjustment.	Check the calibration value of the weight and use the proper calibration weight.
ERR718	The mass of the calibration weight is under 50% of the maximum capacity at "span adjustment" or "internal span adjustment weight adjustment" by external calibration weight.	Use the calibration weight of which weight is equal to the maximum capacity.

Error Message/ Error Code	Cause	Coping method
ERR719	The adjust value by "external span adjustment" or "internal span adjustment" is over 1% of the maximum capacity.	<ul style="list-style-type: none"> - Execute <637 REF CAL RESTORE>, then execute internal span adjustment. - Check the mass of the weight used for the external span adjustment. - Execute <636 REF CAL>.
ERR722	- Tare key is pushed during the Preset tare operation.	Do not push the Tare key during the Preset tare operation.
ERR723	Out of Zero adjustment range (1.5% of the maximum capacity)	Make sure nothing on the weighing pan while executing zero adjustment.
ERR724	Out of Tare subtraction range (0g to the maximum capacity)	Chose the tare of which weight is within the tare subtraction range.
ERR734	Weight of the sample is out of the importing range at actual value setting method at Percent weighing mode (lower limit to maximum capacity).	Load the sample of which weight is within the importing range.
ERR735	Time-out error of importing the sample weight in the actual value setting method at Percent weighing mode.	<ul style="list-style-type: none"> - Improper setting of the weighing pan or pan base is suspected. - Check for contact with other object. - Check for any wind or vibration.
ERR736	The setting value is out of the setting range at numeric value setting method at Percent weighing mode (lower limit to maximum capacity).	Set the value within the range.
ERR737	<ul style="list-style-type: none"> - Sample weight in the air is out of the importing range at specific gravity mode (over 0g to maximum capacity). - Sample weight in the water/liquid is out of the importing range at specific gravity mode ("0 – maximum capacity" to "maximum capacity"). 	<ul style="list-style-type: none"> - Divide the sample so as to its weight in the air is within the importing range. - Divide the sample so as to its weight in the air is within the importing range.
ERR738	Time-out error of importing the sample weight in the water/liquid at specific gravity mode.	<ul style="list-style-type: none"> - Improper setting of the weighing pan or pan base is suspected. - Check for contact with other object. - Check for any wind or vibration.
ERR739	Time-out error of importing the sample weight in the actual value setting method at Preset tare setting.	<ul style="list-style-type: none"> - Improper setting of the weighing pan or pan base is suspected. - Check for contact with other object. - Check for any wind or vibration.
ERR740	The setting value is out of the setting range at numeric value setting method or actual value setting method at Preset tare setting (0g to maximum capacity).	Set the tare of which weight is within the tare subtraction range.
ERR741	<631 EX CAL> is executed while the external span adjustment function is disabled.	Contact the store where you purchased the product.
ERR742	Internal span adjustment device is out of working order.	Contact the store where you purchased the product.
ERR743	Battery power supply is lacking to execute <633 INT CAL> or <634 INT SPAN TEST> or <636 REF CAL>.	Replace batteries to new ones.
ERR746	Invalid date or time was input at <647 DATE SETTING> or <648 TIME SETTING>.	Set the date and time correctly.

Error Code	Cause	Coping method
ERR747	Time-out error of importing the sample weight in the actual value setting method at Comparator function.	<ul style="list-style-type: none"> - Improper setting of the weighing pan or pan base is suspected. - Check for contact with other object. - Check for any wind or vibration.
ERR748	The setting value is out of the setting range at numeric value setting method or actual value setting method at Comparator mode ("0 – maximum capacity" to "maximum capacity").	Set the value within the range.
ERR749	Time-out error of importing the sample weight in the actual value setting method at Adding function.	<ul style="list-style-type: none"> - Improper setting of the weighing pan or pan base is suspected. - Check for contact with other object. - Check for any wind or vibration.
ERR750	<ul style="list-style-type: none"> - Weight of the sample to add is out of the importing range ("0 – maximum capacity" to "maximum capacity"). - The total value has exceeded the maximum display digit. 	<ul style="list-style-type: none"> - Choose the sample of which weight is within the importing range. - Clear the total value.
ERR751	The unit weight of the samples is lighter than the minimum interval of the balance at Counting mode.	Choose the samples of which unit weight is larger than the minimum interval of the balance.
ERR752	The unit weight of the samples is 0g and under at Counting mode.	<ul style="list-style-type: none"> - Choose the samples of which unit weight is larger than the minimum interval of the balance. - Counting mode cannot operate subtractive counting.
ERR753	Time-out error of importing the unit weight at Counting mode.	<ul style="list-style-type: none"> - Improper setting of the weighing pan or pan base is suspected. - Check for contact with other object. - Check for any wind or vibration.
ERR754	Deleted the latest data then executed deleting operation of the second latest data at statistics mode.	<ul style="list-style-type: none"> - Only the latest data can be deleted. - Select <ALL> to delete all the other data.
ERR760	Adding operation is executed while the Adding function is disabled.	Set <141 ACTIVATE> ON then execute the adding operation.
ERR761	An error occurred at <636 REF CAL>.	Re-execute <636 REF CAL>.
ERR763	The calculation error of the specific gravity of the sample at specific gravity mode.	Re-execute the specific gravity function.
ERR764	External weight used for <631 EX CAL> is different from the selected weight range at <SELECT WEIGHT>.	Use the external weight of which weight is within the selected range.
ERR768	The setting value is out of the range at <639 ERROR INPUT>.	Use the external calibration weight whose error is $\pm 100\text{mg}$ and under.
ERR769	Calculation error of solid specific gravity.	Re-execute specific gravity measurement.
ERR770	Calculation error of liquid specific gravity.	Re-execute specific gravity measurement.

10 How to maintain

1 Remove the pan and pan base.

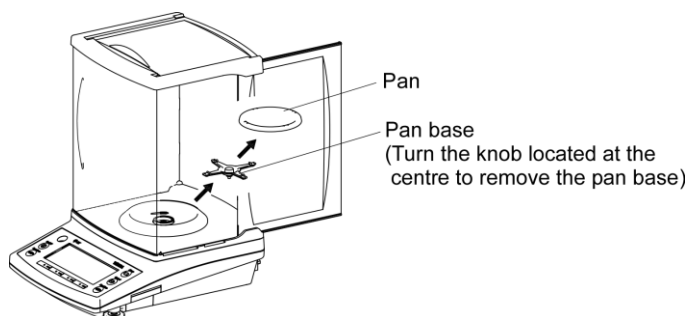

2 Turn the windshield ring counterclockwise until it stops.

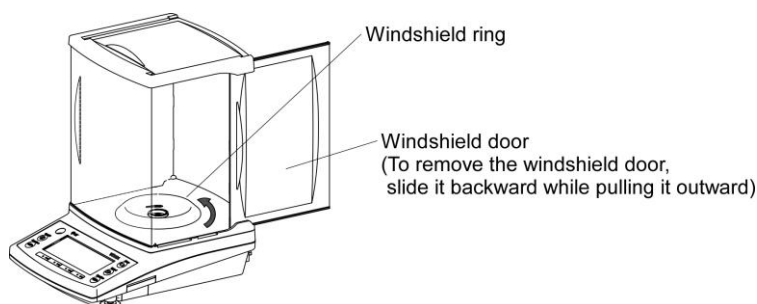

3 Pull the windshield straight up to remove it.

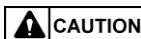
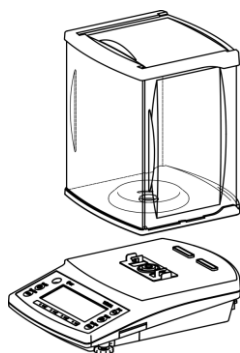

CAUTION

When the windshield is removed, take care that no dust or liquid gets in the balance.

5 Maintenance method.

- (1) Wipe dirt with dry and soft cloth to the balance.
- (2) In the case of heavy soil, dismount the weighing pan and/or the pan-base and clean them with a piece of cloth slightly wet with neutral detergent.

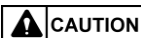

CAUTION

Do not use items such as chemical agents, solvents, or wipes that could damage the windshield panel.

Appendix

Appendix 1 Specification

Appendix 1-1 Basic Specification

For non 

Model	Max	d	Indication limit	Counting mode minimum unit weight	Percentage mode weight limit	Dimensions of the pan	Span adjustment		
HT84CEN	80000 mg	0.1 mg	80009.0 mg	0.0001 g	0.01 g	φ80 mm	External		
	80 g	0.0001 g	80.0090 g						
	400 ct	0.0005 ct	400.090 ct						
HT124CEN	12000 mg	0.1	120009.0	0.0001 g	0.01 g		φ80 mm	External	
	120 g	0.0001	120.0090						
	600 ct	0.0005	600.090						
HT224CEN	220000 mg	0.1 mg	220009.0 mg	0.0001 g	0.01 g	φ80 mm		External	
	220 g	0.0001 g	220.0090 g						
	1100 ct	0.001 ct	1100.090 ct						
HT84RCEN	80000 mg	0.1 mg	80009.0 mg	0.0001 g	0.01 g		φ80 mm	Internal and External	
	80 g	0.0001 g	80.0090 g						
	400 ct	0.0005 ct	400.090 ct						
HT124RCEN	12000 mg	0.1	120009.0	0.0001 g	0.01 g	φ80 mm			Internal and External
	120 g	0.0001	120.0090						
	600 ct	0.0005	600.090						
HT224RCEN	220000 mg	0.1 mg	220009.0 mg	0.0001 g	0.01 g		φ80 mm	Internal and External	
	220 g	0.0001 g	220.0090 g						
	1100 ct	0.001 ct	1100.090 ct						

For

Legal Metrology

Model	Max	Min	e	d	Indication limit	Accuracy Class	Counting mode minimum unit weight	Percentage mode weight limit	Dimensions of the pan	Span adjustment
HT84CEN	80000 mg	10 mg	1 mg	0.1 mg	80009.0 mg	I			φ80 mm	External
	80 g	0.01 g	0.001 g	0.0001 g	80.0090 g	I	0.0001 g	0.01 g		
	400 ct	0.02 ct	0.01 ct	0.001 ct	400.090 ct	II				
HT124CEN	120000 mg	10 mg	1 mg	0.1 mg	120009.0 mg	I				
	120 g	0.01 g	0.001 g	0.0001 g	120.0090 g	I	0.0001 g	0.01 g		
	600 ct	0.1 ct	0.01 ct	0.001 ct	600.090 ct	I				
HT224CEN	220000 mg	10 mg	1 mg	0.1 mg	220009.0 mg	I				
	220 g	0.01 g	0.001 g	0.0001 g	220.0090 g	I	0.0001 g	0.01 g		
	1100 ct	0.1 ct	0.01 ct	0.001 ct	1100.090 ct	I				
HT84RCEN	80000 mg	10 mg	1 mg	0.1 mg	80009.0 mg	I			Internal and External	
	80 g	0.01 g	0.001 g	0.0001 g	80.0090 g	I	0.0001 g	0.01 g		
	400 ct	0.02 ct	0.01 ct	0.001 ct	400.090 ct	II				
HT124RCEN	120000 mg	10 mg	1 mg	0.1 mg	120009.0 mg	I				
	120 g	0.01 g	0.001 g	0.0001 g	120.0090 g	I	0.0001 g	0.01 g		
	600 ct	0.1 ct	0.01 ct	0.001 ct	600.090 ct	I				
HT224RCEN	220000 mg	10 mg	1 mg	0.1 mg	220009.0 mg	I				
	220 g	0.01 g	0.001 g	0.0001 g	220.0090 g	I	0.0001 g	0.01 g		
	1100 ct	0.1 ct	0.01 ct	0.001 ct	1100.090 ct	I				

Appendix 1-2 Functional specification	
----------------------------------------------	--

Item	Description
Weighing system	Tuning-fork vibration method
Measuring mode	Weighing/Counting/Percentage/Multiplied by Coefficient/Specific gravity (solid/liquid)
Function	- Function related to the operation Comparator/Adding/Tare-subtraction reminder/Zero-point adjustment reminder/Stability waiting/Bar graph/Backlight/Auto power-off/Simple SCS
	- Function related to the performance Stability discrimination width/Response speed/Zero tracking
	- User information setting Preset tare/Weight/Percentage/Counting/ Multiplied by Coefficient/ Comparator
	- Functions related to the lock Total lock release/Key lock/Menu lock
	- Controlling and adjustment functions Shortcut/Free key/balance ID/Password/Output language (English, Japanese)/Date/Time setting/Designation of minimum indication/Span adjustment at power on/Direct start/Initialize
	- Other functions which can be assigned to free keys GLP footer, header output/Date indication/Time indication/Balance ID indication
Display	LCD with backlight
	7-segment: Maximum 8-digit/Segment height up to 16.5mm
	16-segment: Maximum 20-digit/Segment height up to 8.5mm
	Bar graph: 30 steps
Tare range setting	Actual weight subtraction with [Zero/Tare] key (Stability waiting: yes/no selectable)
Zero tracking	Provided (Can be disabled via setting)
Display when overloaded	When indication limit is exceeded, <OVER ERROR> is indicated. (See Appendix 1-1 "Basic Specification".)
Output	RS-232C compliant output is equipped as standard (D-sub9P Male connector, DIN8P connector)
Compatible printer	CBM-910II
Calibration	HTRCEN Type: - Semi-automatic/automatic span adjustment/test by internal calibration device - Semi-automatic span adjustment/test with external weight - Advice CAL
	HTCEN Type: - Semi-automatic span adjustment/test with external weight - Advice CAL
Power	Dedicated AC adapter (100-240VAC / 50-60Hz)
Ratings	AC adapter jack: 12VDC 0.9VA (Maximum power consumption)
Weight of the balance (NET)	HTCEN Type: Approximately 2.5 kg
	HTRCEN Type: Approximately 2.9 kg
Operating condition	Temperature: 10-30°C
	Humidity: 80% RH or lower (no condensation)
	Pollution degree: 2
	Altitude: 2000m or less above sea level
	Location of use: Indoor use only
Option	Specific gravity measurement kit

Appendix 2 Dimensional outline drawing

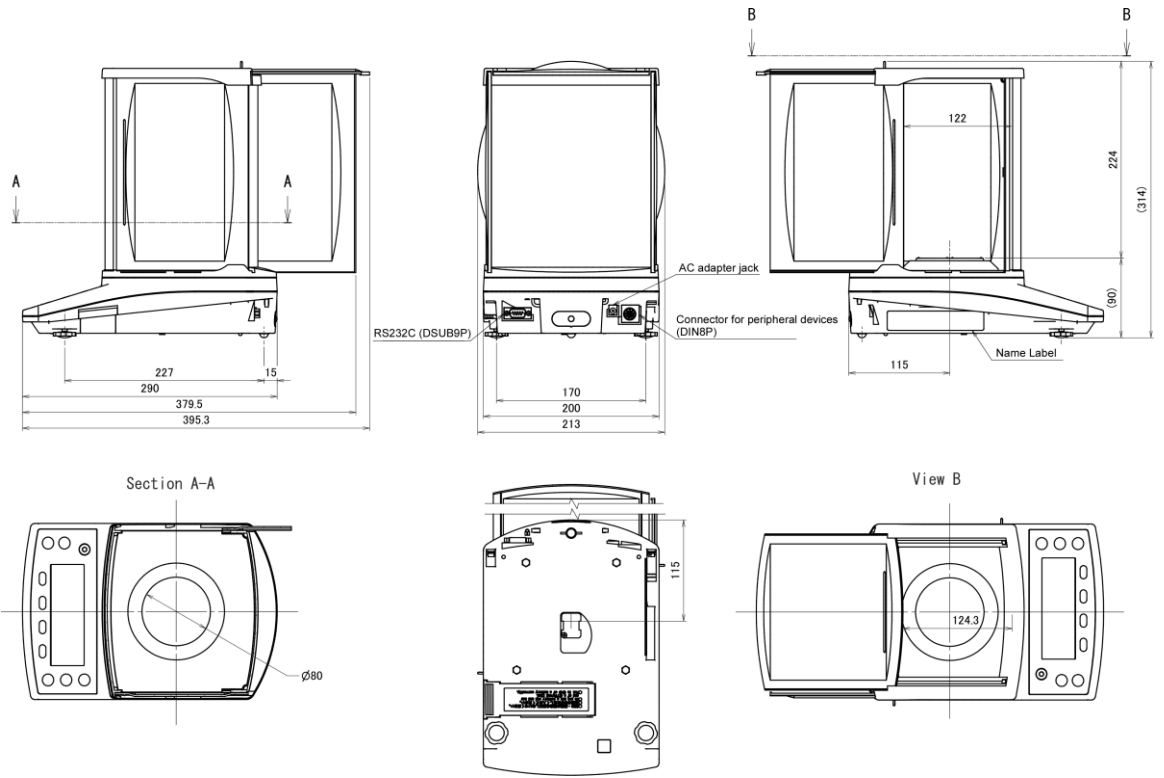

Appendix 3 Unit conversion table

Unit indication	Conversion coefficient
1 g (gram)	1.00000000E+00
1 ct (carat)	5.00000000E+00
1 lb (pound)	2.2046226E-03
1 oz (ounce)	3.5273961E-02
1 oz t (troy ounce)	3.2150746E-02
1 GN (grain)	1.5432358E+01
1 dwt (pennyweight)	6.4301493E-01
1 mom (momme)	2.6666667E-01
1 MSG (mesghal)	2.16999761E-01
1 t:H (Hong Kong tael)	2.6717251E-02
1 t:S (Singapore, Malaysia tael)	2.6455471E-02
1 t:T (Taiwan tael)	2.6666667E-02
1 to (tola)	8.5735324E-02
1 BA t (baht)	6.59630607E-02
1 mg (milligram)	1.00000000E+03

Appendix 4 Weighing capacity and readability by unit

 For NON Legal
Metrology



Unit	Model		
	HT84(R)CEN	HT124(R)CEN	HT224(R)CEN
g gram	80 0.0001	120 0.0001	220 0.0001
ct carat	400 0.0005	600 0.0005	1100 0.001
lb pound	0.17 0.000001	0.26 0.000001	0.48 0.000001
oz ounce	2.8 0.000005	4.2 0.000005	7.7 0.000005
oz t troy ounce	2.5 0.000005	3.8 0.000005	7 0.000005
GN grain	1200 0.002	1800 0.002	3300 0.002
dwt pennyweight	51 0.0001	77 0.0001	140 0.0001
mom momme	21 0.00005	32 0.00005	58 0.00005
MSG mesghal	17 0.00005	26 0.00005	47 0.00005
t : H Hong Kong tael	2.1 0.000005	3.2 0.000005	5.8 0.000005
t : S Singapore / Malaysia tael	2.1 0.000005	3.1 0.000005	5.8 0.000005
t : T Taiwan tael	2.1 0.000005	3.2 0.000005	5.8 0.000005
to tola	6.8 0.00001	10 0.00001	18 0.00001
BA t baht	5.2 0.00001	7.9 0.00001	14 0.00001
mg milligram	80000 0.1	120000 0.1	220000 0.1

For 

Unit		Model		
		HT84(R)CEN	HT124(R)CEN	HT224(R)CEN
mg milligram	Max	80000	120000	220000
	Min	10	10	10
	e	1	1	1
	d	0.1	0.1	0.1
	Class	I	I	I
g gram	Max	80	120	220
	Min	0.01	0.01	0.01
	e	0.001	0.001	0.001
	d	0.0001	0.0001	0.0001
	Class	I	I	I
ct carat	Capacity	400	600	1100
	Min	0.02	0.1	0.1
	e	0.01	0.01	0.01
	d	0.001	0.001	0.001
	Class	II	I	I

Appendix 5 Hanging measurement

The balance is equipped with a hanging hook to suspend a hanging pan for weighing. Perform hanging measurements when weighing electromagnetic, electrostatic, or high-temperature samples that cannot be accurately weighed on the normal pan.

 CAUTION	<ul style="list-style-type: none"> - Be sure to close the cover of the hanging hook when not in use to prevent dust from entering the balance.
	<p>Hanging measurement is not legal for trade.</p>
	<ul style="list-style-type: none"> - Tools (hanging pan etc.) suspended from the hook are regarded as a <i>tare</i> (container). Weights equal to the weighing capacity cannot be measured. <p>Measurable weight = Weighing capacity + Weight of the pan - Total weight of tools suspended</p>

1 Installation

Disconnect the AC adapter, remove the pan and gently tilt the balance backward.

Take care that the door does not fall off.

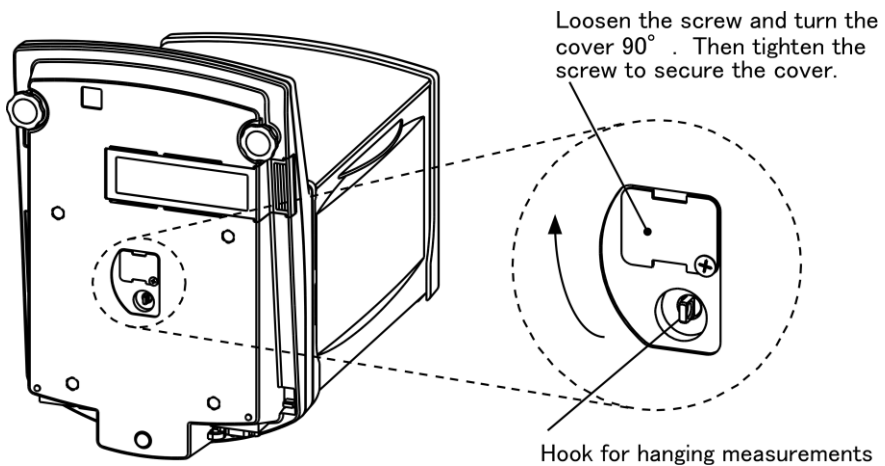

Appendix 6 Balance operation with password control function

This chapter describes how to use the balance with "8-5-2 Password control". This function is useful for setting different authority for each user/guest.

Appendix 6-1 User's authority setting

1 Power on the balance.

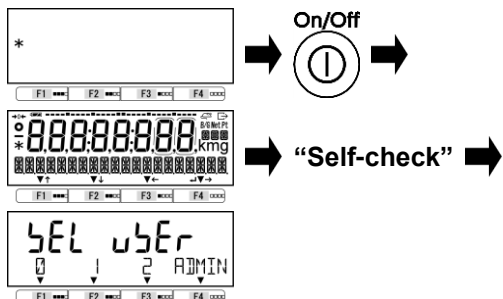

Enable the <642 PASSWORD> and register the administrator password in <643 SET ADMIN PASS>, then power-off the balance. Push [On/Off] key, then the balance shifts to User login mode after start-up operation.

2 Go to the Administrator login mode.

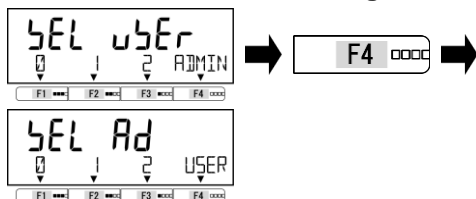

Push [F4] key to go to "Administrator login mode".

<SEL Ad> is indicated on the 7-segment display.

3 Select the user to set the authority.



Select the user

- 0 : Guest user
- 1 : User 1
- 2 : User 2

USER : Shift to the User login mode

4 Input the administrator password.



Input the administrator password by pushing [F1-F4] keys.

Each digit increments as "0, 1, ..., 8, 9, 0" by pushing each [F] key.

- First digit from the left : [F1] key
- Second digit from the left : [F2] key
- Third digit from the left : [F3] key
- Fourth digit from the left : [F4] key

5 Start up the balance.



Push [Output] key.

When the password is authenticated, the balance starts up.

6 Register the user password.

Refer to "8-5-2(2) User password registration".

Reference	(1) The user password of which selected in Step 3 is registered. (2) When "0: Guest user" is selected at step 3, skip this step.
------------------	-------------------------------------------------------------------------------------------------------------------------------------

7 Set the functions and setting values which are intended to be fixed.

Refer to “3 Functions related to the operation”, “4 Functions related to the performance”, “5 User information setting”, “6 External input/output functions” and “8 Controlling and adjustment functions” to set functions/setting values to be fixed.

Reference <5 LOCK> and <6 ADMIN/ADJUST> are displayed only for the administrator. When to authorize each user to operate “Span adjustment with internal/external weight”, “Adding function”, etc., please assign the functions to <<F1-F6>> (Free key). (Refer to “8-3 Free key settings”.)

8 Set the user’s authority (Lock setting).

Refer to “7 Functions related to the lock” to set user’s authority for key operation and/or accessing to setting menus.

Appendix 6-2 User/guest login

1 Power on the balance and go to the User login mode.

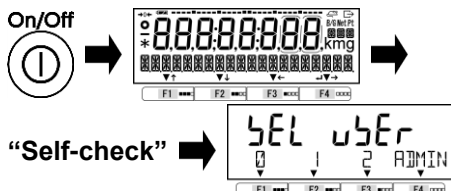

Push [On/Off] key, then the balance shifts to User login mode after start-up operation. <SEL USER> is indicated on the 7-segment display.

2 Select the user number.



Select the user (operator) number;
 0: Guest user
 1: User 1
 2: User 2
 ADMIN: Shift to the Administrator login mode

3 Input the user password.



Input the user password by pushing [F1-F4] keys.

Each digit increments as “0, 1, ..., 8, 9, 0” by pushing each [F] key.

- First digit from the left : [F1] key
- Second digit from the left : [F2] key
- Third digit from the left : [F3] key
- Fourth digit from the left : [F4] key

4 Start up the balance.



Push [Output] key.

When the password is authenticated, the balance starts up.

5 Use the balance with the user’s/guest’s authority.

Lock setting configured by administrator is reflected.

Reference When “0: Guest user” is selected at step 2, step 3 and 4 are skipped.

Index of Terms

16-segment	12	numeric value	10, 18
7-segment	12	numeric value setting method	22, 25, 43, 45
absolute value	32, 45	operation keys	9
actual value setting method	22, 25, 43, 45	output conditions	60
adding function	33	parity bit	60
administrator	79	password	78, 97
auto power-off	39	percentage mode	19, 25, 65
backlight	38	plus side function	34
balance ID	78	preset tare	43, 58
bar graph	38	printing	82
basic data output format	49	readability	66, 83
baud rate	60	reference value	32, 45
calibration	73	relative value	32, 45
CBM data output format	51	response	59
communication condition	60	response command	60
communication format	49	response speed	41, 66
comparator	58	restore	74
comparator function	31, 45	RS-232C	47
comparator output	60	segment	11
counting mode	19, 22, 65	setting menu	17
date	66, 80	setting value	10, 17
date output	57	Simple SCS method	39
direct start	84	span adjustment	67, 80, 83
error	85	span test	67, 80
external contact input	59	Special format	53, 54
external input/output	47	specific gravity mode	19, 28, 65
external span adjustment	66	specification	89
external weight	67	stability discrimination width	40
free key	66	stabilization wait setting	37
GLP footer	66	stop bit	60
GLP header	66	tare	15
guest	98	tare value	66
hold	66	tare-subtraction reminder function	36
ID number	66	time	66, 82
initialize	84	time output	57
input command	56	total	66
internal span adjustment	66	total lock release	61
internal weight	70	total value	34, 35
key lock function	62	unit	31, 93, 94
LCD character	12	unused high order digit	60
level	8	upper limit value	32, 45, 66
lock	61	user	79, 98
lower limit value	32, 45, 66	water temperature	28
measuring mode	19, 21, 65	weighing mode	19, 21, 65
menu lock function	62	zero tracking	41
minus side function	35	zero-point adjustment	14
multiplied by coefficient mode	19, 27, 65	zero-point-adjustment reminder function	37
net value	60		

